



SCHÖCK SCONNEX®

Closing the last major thermal bridge.



Structural thermal breaks for effective reduction of thermal bridges in walls and columns.

CHALLENGE

The vision of a continuously insulated building envelope.

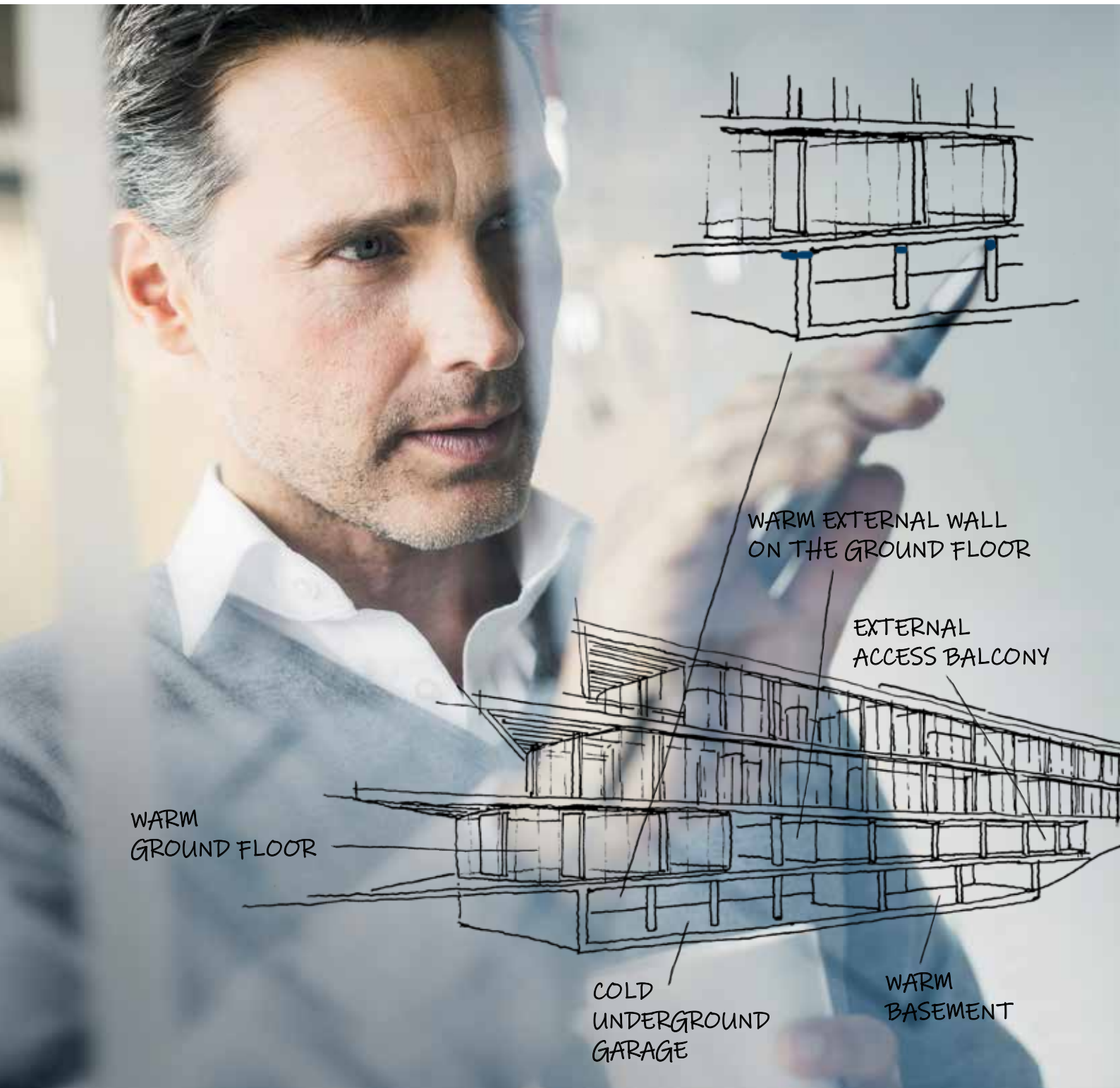

The future of construction must align itself to the increasingly complex challenges of society. We offer future-proof solutions by using innovative products to create comprehensive concepts.

Climate protection and sustainability are becoming ever more critical for the construction industry, among others. The result is an increase in demand on building insulation. The main focus of the 2050 building policy guidelines is the reduction of energy losses. More attention is being paid to thermal bridges in particular. They are the last remaining option for significantly improving the energy balance of buildings.

Previously, thermal bridges present in wall and column connections have led to high energy losses. Condensation and mould frequently also cause structural damage at these points.

The required additional energy savings can only be achieved by employing continuously insulated building envelopes that also include consistent insulation of thermal bridges in the building base.

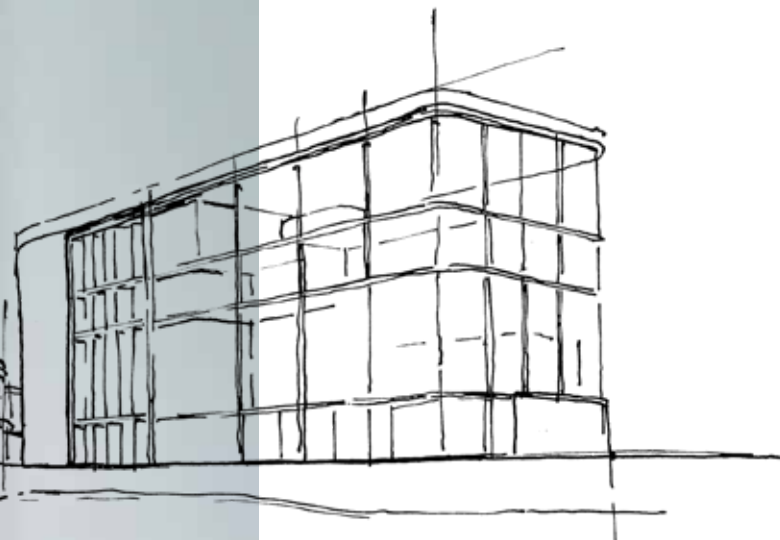

Approx. **40%**
of all structural thermal
bridges in buildings are
caused by walls and columns.

The thermal bridges in walls
and columns are responsible
for approx. **10%**
of the heating energy loss.

SOLUTION

A new product family with its eye on the future.

Schöck is applying its expertise in balconies to walls and columns with the new Sconnex® product family. As the logical development of a successful technology for the direct and permanent insulation of thermal bridges, Schöck Sconnex® is a breakthrough for energy-efficient construction and sustainable building concepts.

A strong family of robust models

Schöck Sconnex® meets a previously unresolved challenge. Walls and columns can be efficiently insulated using Sconnex® type W, type P and type M.



Sconnex® type W

The structural thermal break for reinforced concrete walls insulates the thermal bridge at the base or the top of the wall and significantly reduces energy losses.



Sconnex® type P

The structural thermal break for reinforced concrete columns insulates the thermal bridge at the column head and eliminates the need for flank insulation.

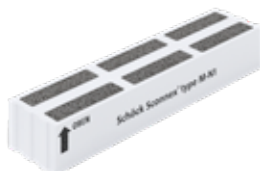

Sconnex® type M

The structural thermal break for masonry walls is a capillary barrier and insulates the thermal bridge at the base or the top of wall from the outset.





Sconnex® type W

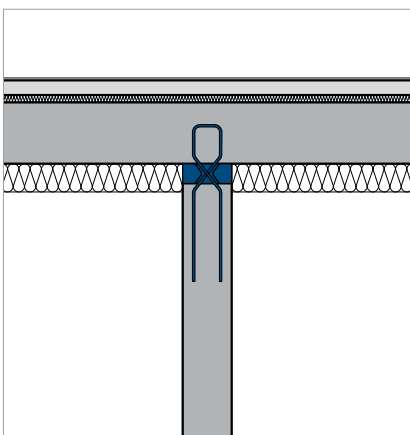

Application at the top of the wall for under-slab insulation.

Sconnex® type P

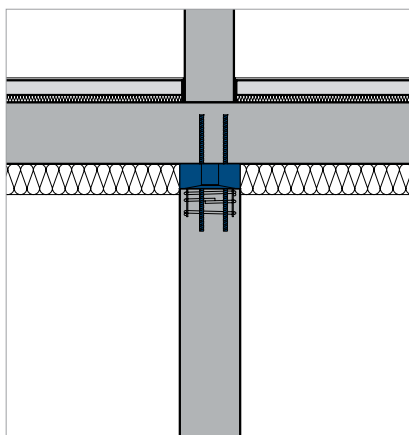

Application at the column head for under-slab insulation.

Sconnex® type M

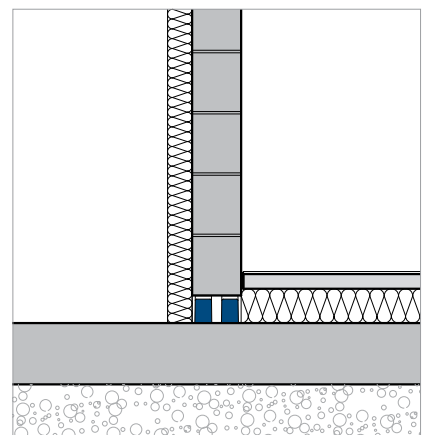

Application with insulation at the base of the wall on the base slab.

BENEFITS

A continuously insulated building envelope is becoming a reality.

Thermal bridges in walls and columns at connections to floor slabs or base slabs cause high energy losses. This results in the formation of condensation and mould. Thermally exposed building components subjected to critical conditions are at particular risk.

Schöck Sconnex® insulates these thermal bridges so that the usual flank insulation is no longer required. This not only improves the quality of the structure but also creates aesthetic and economic advantages.

Building physics

- High wall surface temperatures protect against structural damage
- Continuous thermal insulation levels result in reliable planning
- Reducing thermal bridges improves energy efficiency

Appearance

- Enhanced appearance through the elimination of flank insulation
- Creative freedom for thermally exposed building components
- More planning freedom for challenging building geometries

Efficiency

- Improves quality and sustainability
- Cost-neutral through the elimination of flank insulation
- Systematic applications reduce the thickness of external insulation





Detached house,
Herborn, Germany
EL Ansari architectural
practice

**Sconnex® creates slim
wall profiles:**
Exposed concrete look
with a lasting thermal
bridge solution.

Thermally exposed building components

Insulating thermally exposed building components contributes significantly to preventing structural damage due to condensation and mould.

Systematic applications

The consistent insulation of walls and columns offers great potential for creativity, building physics and economic optimisation.

Note

Sconnex® type W can be used for specific building components in many applications after coordination with the structural engineer.

Schöck product engineers will be happy to assist you with approval applications.

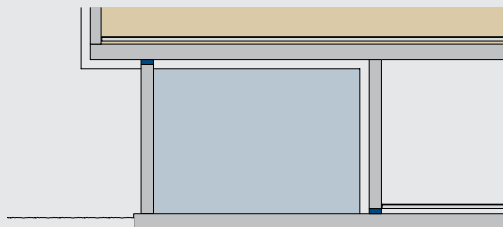

Undercuts / façade projections



Underground garage / basement: above-slab insulation

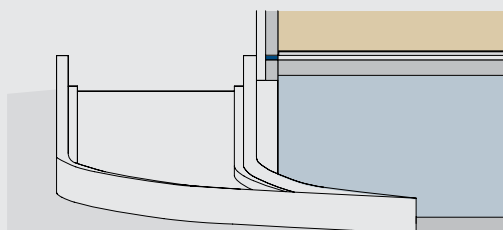

Entries to underground garages



Underground garage / basement: under-slab insulation

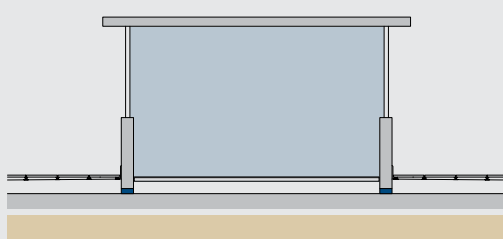

Cold building parts on flat roofs, e.g. machine rooms

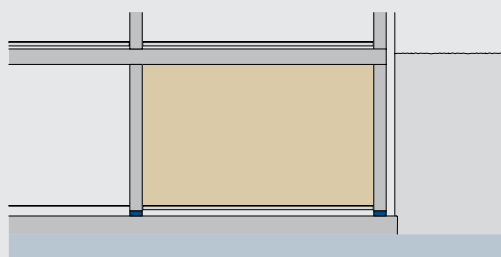

Laundry room / sauna: base slab solution

■ Warm zone
■ Cold zone

The new standard: Outstanding insulation values and maximum planning reliability.

Direct insulation of thermal bridges on walls and columns reduces energy losses. This prevents damage caused by condensation and mould. A continuously insulated building envelope guarantees additional planning reliability and helps to achieve higher energy standards.

Sconnex® type W
Connection detail of reinforced concrete wall in underground garage with below-slab insulation. Living area above underground garage with wall connected on top of wall.

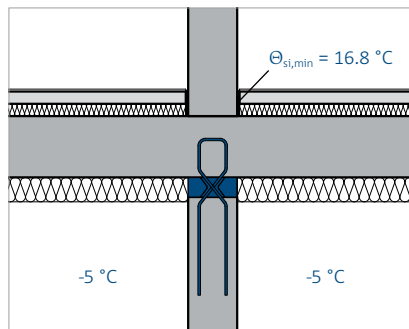

Sconnex® type P
Connection detail of columns in underground garage with insulation under the floor slab. Living area above underground garage with wall lying above column.

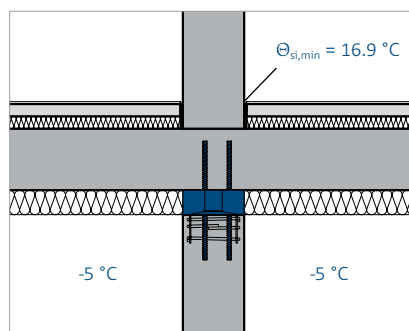

Sconnex® type M
Connection detail of masonry wall with an above-slab insulation.

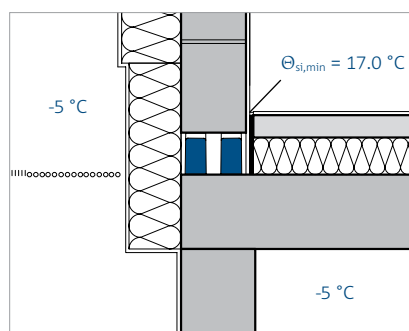

Healthy indoor climate

Thermally exposed building components rapidly reach the limits of technical feasibility with regard to building physics. Sconnex® provides good protection against moisture and heat and so provides a critical advantage in cases such as these.

Reliable energy planning

For the first time, thermal insulation levels can be comprehensively planned for walls and columns. Complex structural details can be developed reliably and simply.

Achieving the requirements to prevent the risk of condensation and mould formation

The temperature factor f_{Rsi} is a value which defines if condensation occurs. The higher the temperature factor, the better the thermal insulation in this area.

To avoid condensation and mould growth an f_{Rsi} value ≥ 0.75 has to be achieved. This corresponds with a surface temperature $> 15^\circ\text{C}$. Especially for living areas above garages this is traditionally difficult to reach without insulating the thermal bridges caused by columns and walls. With Sconnex high surface temperatures can easily be reached.



Hörnlühütte, Matterhorn, Switzerland. Photograph: Michel Bonvin

Enormous energy-saving potential

Schöck Sconnex® reduces the heat transfer coefficient and so helps buildings to meet the highest energy standards without requiring flank insulation, which is less energy efficient. If under-slab insulation is employed, heat loss is reduced by up to

59%: if above-slab insulation is used, heat loss is reduced by up to 80%. When applied systematically, decoupling entire buildings from cold floors can result in the entire insulation concept being adapted and can save on insulation.

Sconnex® on the ascent: Schöck Sconnex® guarantees efficient thermal insulation, even under the extreme climatic and geological conditions found in the Alps.

Application case with under-slab and above-slab insulation

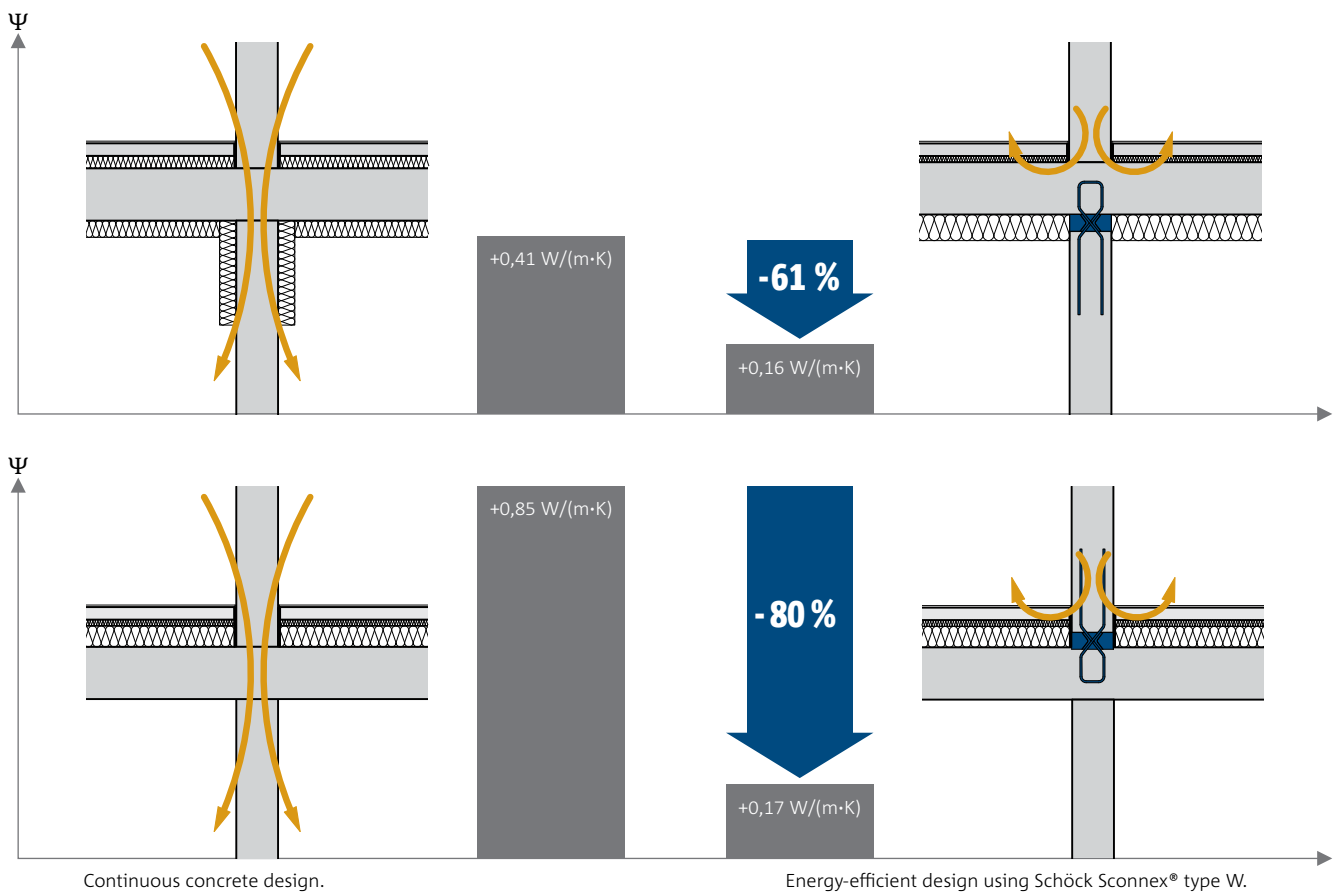

APPEARANCE

Freedom of design without compromise.

Flank insulation used to reduce thermal bridges on walls and columns frequently imposes limitations on design. In contrast, Schöck Sconnex® opens up new areas of freedom for reconciling challenging geometries and elegant shapes with energetic requirements. The various Sconnex® product variants are suitable for specific requirements.

The efficient solution for ambitious building geometries

When designing high-energy efficient buildings, architects aim to prevent thermal bridges from the outset of the planning phase to ensure that the required structural-physical target values are met. This frequently causes creative limitations and constraints. Now, Schöck Sconnex® can be used to effectively insulate previously

unavoidable thermal bridges on façade protrusions, recessed balconies, access balconies and other architectural design elements. This structural and physical optimisation lays the groundwork for creating even very ambitious building geometries that comply with the highest energy standards.

Improved aesthetics

Left: Reinforced concrete wall implemented using Schöck Sconnex® type W.

Right: Reinforced concrete wall using conventional flank insulation.





Enhanced appearance

Attaching flank insulation to walls and columns results in unsightly material and surface transitions and takes up additional visual space, all of which can result in unsatisfactory design results in underground garages and basements. It is true that insulation solutions can be visually improved by rendering or facing the flank insulation. However, this is costly and less energy efficient and so mostly the build-

ings can either only just fulfil the regulatory requirements for thermal protection and damp-proofing or fail to fulfil them entirely. Using Sconnex®, these regulatory requirements can be met and underground garages and basements, for example, can be given a sophisticated finish. This improves the quality of the entire building.

Quasar, Erlinsbach, Switzerland
Photo: Kreis Hirschi AG

Versatile Sconnex®: The innovative insulation solution allows for ambitious aesthetics and slender shapes.

Space-saving



Left: Column solution implemented using Schöck Sconnex® type P.

Right: Column solution implemented using conventional flank insulation.

ECONOMIC EFFICIENCY

Better quality without increased costs.

Sustainable and durable building concepts based on high-quality planning and faultless implementation. Sconnex® improves the quality of the entire building.

It also potentially saves substantial amounts of money due to the elimination of flank insulation. When applied systematically to decouple entire buildings from cold floors, it can even reduce the cost considerably by saving on insulation.

Thermally exposed building components

Cost reduction of individual components:

- Elimination of flank insulation (material and labour costs)
- No rendering or painting necessary
- Simplified cable and/or pipe routing
- Eliminates complex insulation processes, particularly around joists
- Simple planning and implementation
- No refurbishment



Sconnex® creates slim wall profiles with an exposed concrete finish and lastingly eradicates thermal bridging.



Systematic application

Cost optimisation for the entire building:

- Reduction or elimination of expensive under-slab insulation
- Cost-effective installation of insulation layer on the floor slab
- Elimination of flank insulation
- Reduction of exterior insulation thickness increases the interior floor space
- Increased interior room height

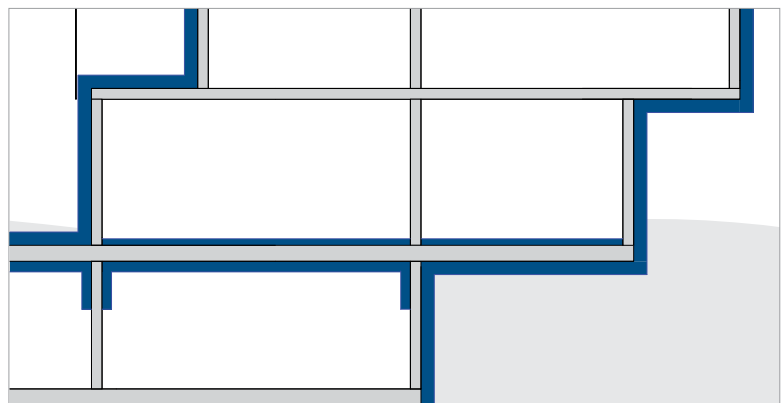

Conventional insulation solution with under-slab and flank insulation

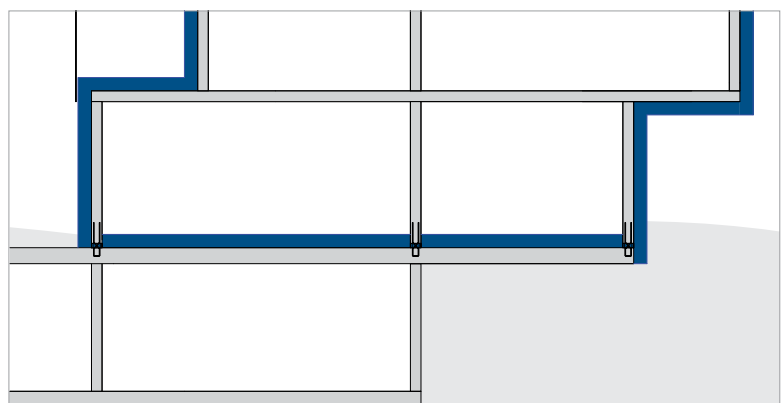

Installation of insulation on the floor slab greatly reduced material expense

REINFORCED CONCRETE WALLS

Sconnex[®] type W



1 Insulating element

The insulating element is made of Neopor (WLG 031).

2 Compression block

The compression block of Schöck Sconnex[®] type W is made of microfibre-reinforced high-performance concrete. The material has very high compressive strength as well as high flexural strength. The addition of steel fibres also produces excellent post-cracking behaviour.

3 Shear force elements

The steel brackets used to transfer shear forces into the thrust block consists of a standard BSt 550 B \varnothing 10 mm. In standard application cases, the steel bars are protected against corrosion by a sufficient covering of concrete.



The articulated connection prevents undesirable rotation forces from being generated in the connection point. Negative interaction between the compressive force and bending moment is cancelled. This simplifies the verification procedure and makes structural design reliable.

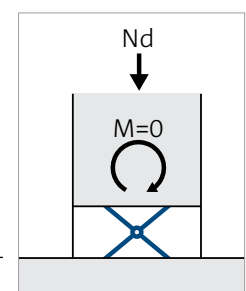

Thermal isolation of walls

Sconnex® type W is a reinforcement connection designed to reduce the flow of heat in reinforced concrete walls. It transfers very high normal forces (compressive and tensile forces) and shear forces in the longitudinal and transverse directions of walls. As a result, load transmission can be perfectly controlled during the structural design phase by adjusting the distances between the elements and by selecting suitable variants.

Advantages and benefits:

Thermal insulation and damp-proofing

- Reduction of energy loss
- Increased wall surface temperatures
- Prevention of structural damage

Installation aid

When installed at the base of a wall, using an installation aid is strongly recommended. The installation aid cannot be used when installing the unit at the top of a wall.



Additional reinforcement

It replaces on-site cross-tensile reinforcements and ensures that pressure is applied with triaxial tension.



Intermediate insulation

Sconnex® type W is a punctual, thermally separating, connecting element. The intermediate area between two elements can be filled with Part Z intermediate insulation.



REINFORCED CONCRETE COLUMNS

Sconnex® type P



1 Part C

This thermal insulation element has a pressure-resistant bearing structure made of lightweight concrete and PP fibres in an insulation layer 100 mm thick. Its special properties reduce the flow of heat considerably and eliminate the need for flank insulation. The glass fibre reinforcement consists of 4 rods of Schöck Combar® D1 and additionally reduces the heat flow.



2 Part T

The Part T reinforcement element is installed immediately below Part C in the column reinforcement. It is made of stainless steel and its strapping effect increases the load-bearing capacity of the connection. It is therefore absolutely vital that this part is installed in accordance with the manufacturer's specifications.

The innovative glass fibre composite material Combar® meets the highest demands for structural insulation. This makes an important contribution to improving the energy balance and to fulfilling UK energy efficiency regulations.

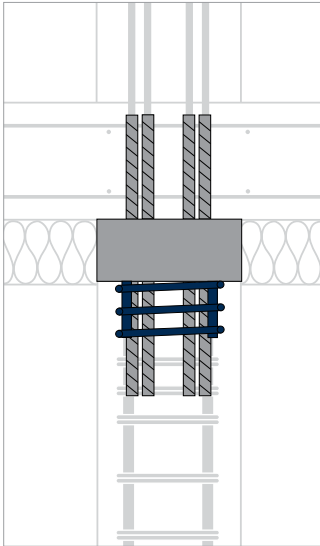

A world first for sophisticated design

Developed especially for reinforced concrete columns, Schöck Sconnex® type P provides effective insulation in connections between reinforced concrete floor slabs and reinforced concrete columns. The thermal insulation element also transfers very high compressive forces. The outstanding insulation properties of Sconnex® type P significantly reduces thermal bridging so there is no need to install costly flank insulation.

Advantages and benefits:

Appearance

- Elimination of flank insulation
- No rendering or painting necessary
- Simplified cable and/or pipe routing

Installation safety:

Certification is essential for the installation and processing of Sconnex® type P. Please contact our installation experts.



MASONRY WALL

Sconnex® type M



1 Insulating element

The insulating element around the concrete compression block consists of polystyrene hard foam.

2 Concrete thrust block

The Schöck Sconnex® type M concrete compression block has a pressure-resistant bearing structure made of light-weight concrete with PP fibres. Its special properties reduce the flow of heat considerably and eliminate the need for flank insulation.

1

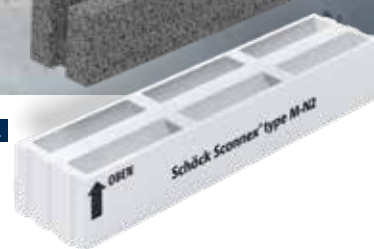

Our proven concrete technology is based on years of development and produces reliably high load-bearing capacities combined with an excellent energy balance.

Note

The product was previously sold under the name Schöck Novomur®.





Sconnex® type M is a capillary barrier. Its hydrophobic characteristics reliably prevent the infiltration of building moisture into the masonry during the construction phase.

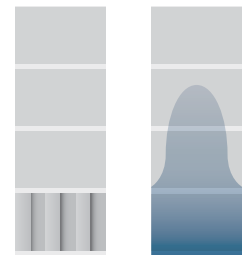

Thermal isolation of masonry walls

The Sconnex® type M energy-saving insulating brick is used to insulate masonry walls exposed to pressure and reduces the thermal bridge at the base of the building. It is used as the first course of brickwork above or below floor slabs and on base slabs and can also be used under facing bricks.

Advantages and benefits:

Maximum protection from day one

- No ingress of moisture into walls
- Thermal insulation from day one
- Reliable prevention of structural damage
- Efficient building process for subsequent trades

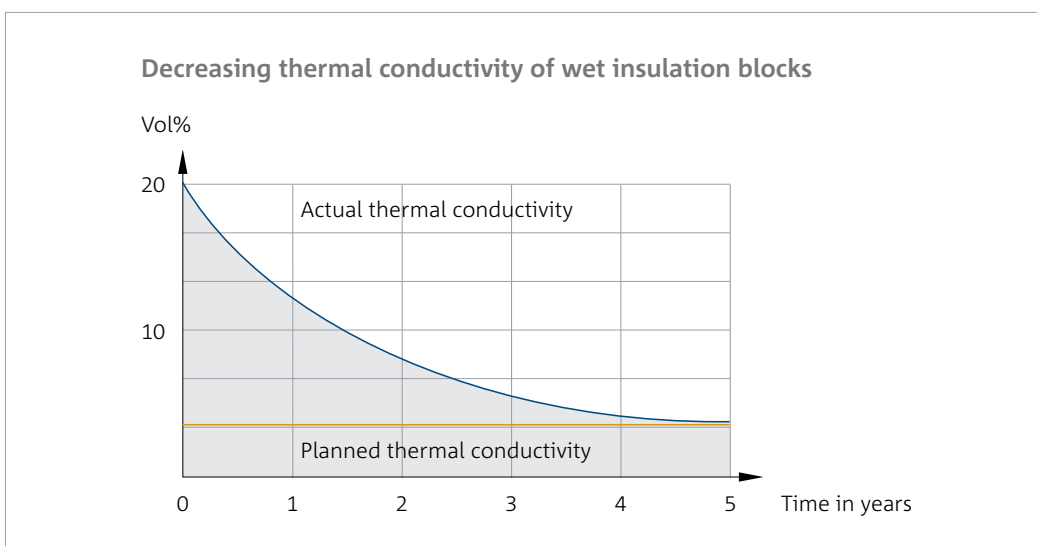

REFERENCES

Technical milestones that inspire in practice.

The advantages and benefits of the Sconnex® types are impressive, and not only in theory. The following superb reference projects all made use of these innovative insulation elements to unify the highest standards of architectural design and energy efficiency.



Hörnlihütte, Zermatt, Switzerland

Groundbreaking lodge architecture with exceptional energy-efficient solution: Thermal bridges were minimised using Schöck Sconnex® – the ideal structural and physical solution for thermal isolation between the warm and cold building components of the lodge.

Photography: Michel Bonvin





Image: Kreis Hirschi AG

Quasar project, municipality of Erlinsbach, Aargau, Switzerland

Efficient thermal insulation that did not limit the elegance of the design was required for these four terraced houses containing three residential units each. When used as a thermally isolating wall connection for reinforced concrete walls, Schöck Sconnex® type W fulfils all requirements and creates an elegant exposed concrete effect in underground garages.



Image: Roger Frei, Zurich

Bläuenstrasse apartment buildings, municipality of Erlinsbach, Aargau, Switzerland

The three staggered apartment buildings each contain four residential units and make a statement for sustainable construction and high quality of life.

Efficient above-slab insulation and insulation of the ground-floor walls in the wall base using Sconnex® type W proved to be a particularly economical solution.

Haberdashers' Aske's Boys' School, Elstree, UK

A two-storey contemporary design created three additional classrooms within this standalone extension to a Preparatory School which features a colonnade to minimize the buildings footprint. The Sconnex type W minimises the thermal bridge at the base of the wall between the exterior wall insulation and the insulation above the colonnades floor slab. Thermal losses are greatly reduced by the Passivhaus element, with the risk of condensation, mould and subsequent structural damage removed.

Image: cube_design



SERVICES

Expertise through every phase of your project.

Every one of our products unites innovative technology and comprehensive expertise. But we also offer much more: Our team will support you as a reliable partner with the greatest commitment and long-standing expertise.

Planning and execution

On the safe side with optimum support



■ Expert advice

Our engineers will advise you comprehensively and help you to find the ideal insulation concept.

■ Technical application advice

For structural and physical issues and for obtaining technical approvals for the use of Sconnex® type W in individual cases.

■ Planning documents

Technical information, structural and physical values and fundamental principles of the application in digital format.

■ BIM libraries

For the integration of detailed Schöck solutions into your overall building plans.

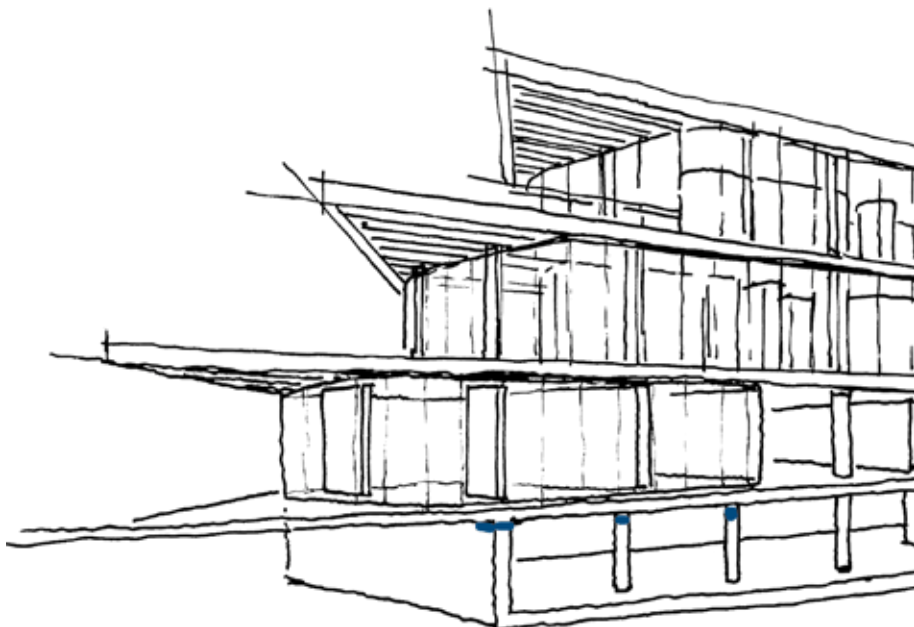



- **Tender support**
Help in creating or answering tenders.
- **Customized solutions**
For non-standard requirements or installation situations.
- **Layout plans, details and section drawings**
Customised to fit your specific project.

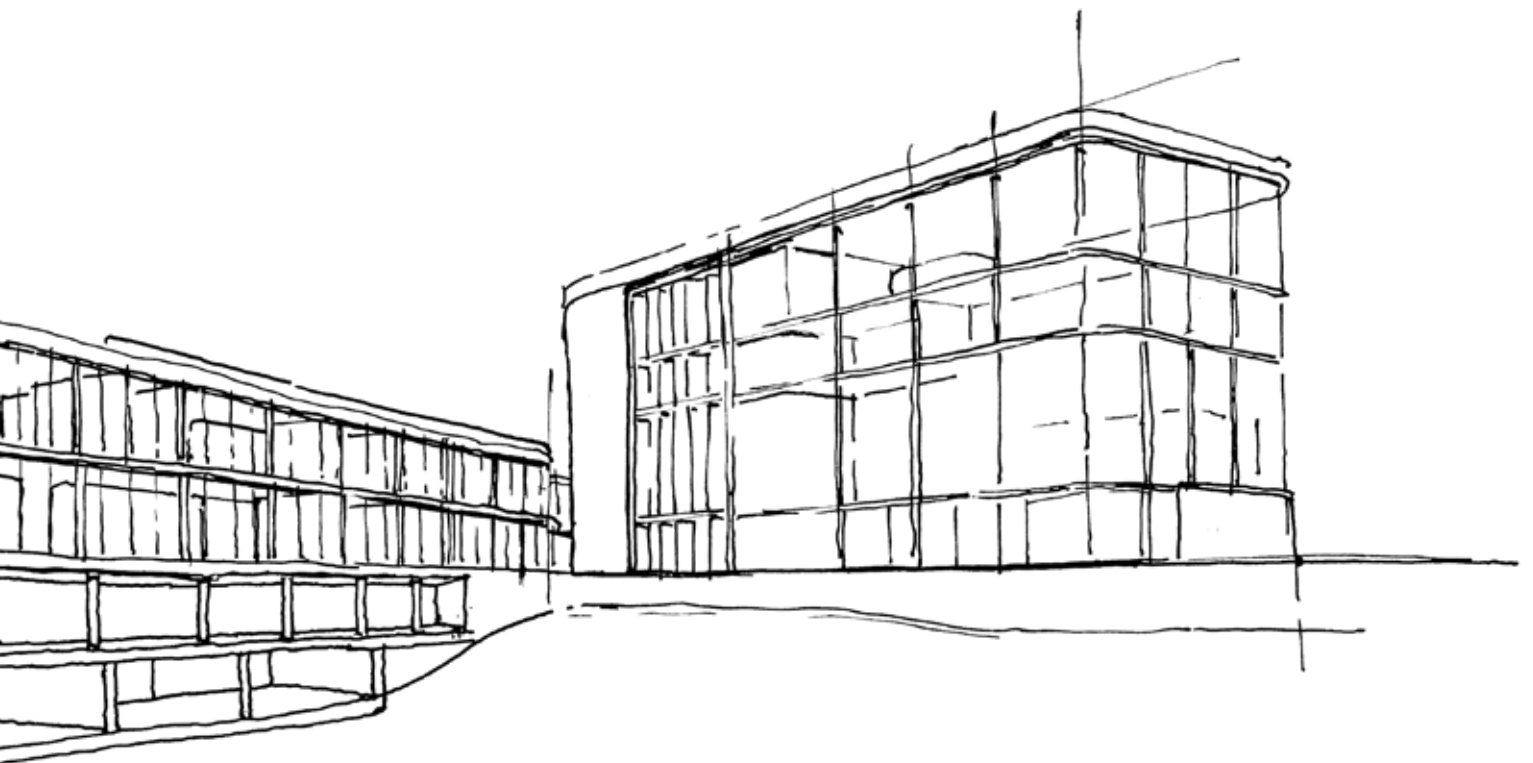

COMPREHENSIVE EXPERTISE

Dependable solutions.

Using our future-proof product solutions and systems, we fulfil all structural, physical and construction requirements of the respective application for new construction projects and existing buildings. Our main areas of focus are the reduction of thermal bridges, impact sound insulation and reinforcement technology.

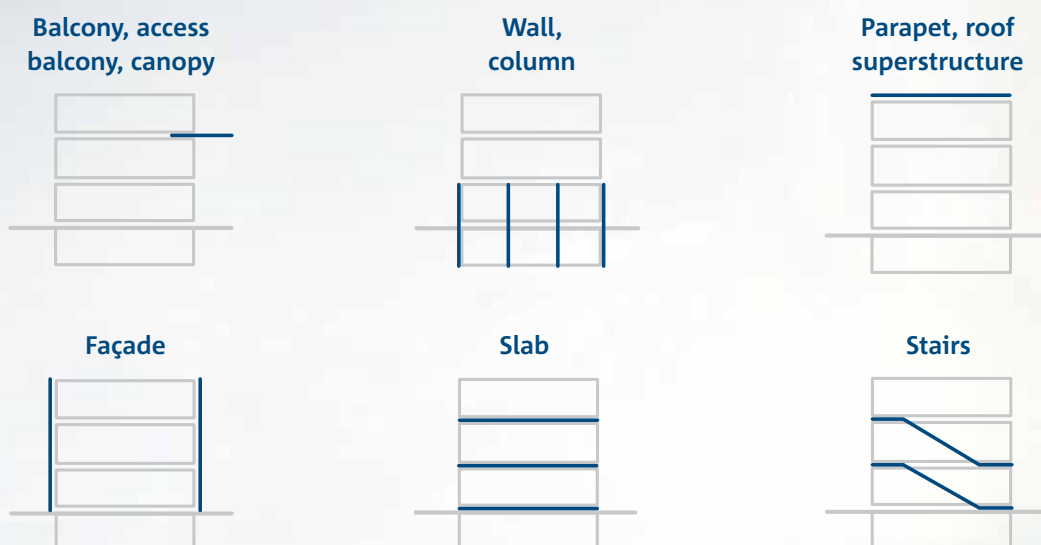

Schöck Bauteile GmbH
Schöckstrasse 1
76534 Baden-Baden
Telephone: +49 7223 967-144
export@schoeck.com
www.schoeck.com