

Approval Z-14.4-518

Schöck Isokorb® T Type S

November 2019

**National technical
approval /
General construction
technique permit****Zulassungsstelle für Bauprodukte und Bauarten****Bautechnisches Prüfamt**Eine vom Bund und den Ländern
gemeinsam getragene Anstalt des öffentlichen Rechts

Mitglied der EOTA, der UEAtc und der WFTAO

Date:

21 Oct 2019

Reference:

I 37-1.14.4-6/19

Number:**Z-14.4-518****Applicant:****Schöck Bauteile GmbH**

Vimbucher Straße 2

76534 Baden-Baden (Steinbach), Germany

Validityfrom: **15 November 2019**to: **15 November 2024****Subject of decision:****Schöck Isokorb® T type S used for joints in steel structures**

The subject named above is herewith granted a national technical approval (*allgemeine bauaufsichtliche Zulassung*) / general construction technique permit (*allgemeine Bauartgenehmigung*). This decision contains 11 pages and 15 annexes.

This national technical approval / general construction technique permit replaces national technical approval no. Z-14.4-518 of 14 November 2014. The subject concerned was granted the first national technical approval on 14 November 2014.

Translation authorised by DIBt**DIBt**

I GENERAL PROVISIONS

- 1 This decision confirms the fitness for use and application of the subject concerned within the meaning of the Building Codes of the federal states (*Landesbauordnungen*).
- 2 This decision does not replace the permits, approvals and certificates required by law for carrying out construction projects.
- 3 This decision is granted without prejudice to the rights of third parties, in particular private property rights.
- 4 Notwithstanding further provisions in the 'Special Provisions', copies of this decision shall be made available to the user and installer of the subject concerned. The user and installer shall also be made aware that this decision must be made available at the place of use or place of application. Upon request, copies of the decision shall be provided to the authorities involved.
- 5 This decision shall be reproduced in full only. Partial publication requires the consent of DIBt. Texts and drawings in promotional material shall not contradict this decision. In the event of a discrepancy between the German original and this authorised translation, the German version shall prevail.
- 6 This decision may be revoked. The provisions contained therein may subsequently be supplemented and amended, in particular if this is required by new technical findings.
- 7 This decision is based on the information and documents provided by the applicant. Alterations to this basis are not covered by this decision and shall be notified to DIBt without delay.
- 8 The general construction technique permit included in this decision also serves as a national technical approval for the construction technique.

II SPECIAL PROVISIONS**1 Subject concerned and field of use and application****1.1 Subject of approval**

This approval covers the following 'Schöck Isokorb® T type S' modules (see Annex 1) from Schöck Bauteile GmbH:

- S-N modules:
- 'Schöck Isokorb® T type S-N-D16' and
 - 'Schöck Isokorb® T type S-N-D22'.
- S-V modules:
- 'Schöck Isokorb® T type S-V-D16' and
 - 'Schöck Isokorb® T type S-V-D22'.

The S-N modules serve to transfer axial forces – primarily tensile normal forces. Each module consists of an insulating element positioned between two 2-mm-thick spacer plates ($W_{min}/H/D$ 150/60/80 mm) and two threaded bars (\varnothing 16 mm or \varnothing 22 mm) with the associated nuts.

The S-V modules primarily serve to transfer axial and shear forces. The axial forces to be transferred are both tensile and compressive forces. Each S-V module consists of two 10-mm-thick or 12-mm-thick pressure plates, an insulating element ($W_{min}/H/D$ 150/80/80 mm); two threaded bars (\varnothing 16 mm or \varnothing 22 mm) with the associated nuts and a welded-in square hollow section (SHS 50x50x3). The exterior sides of the steel plates are laminated with PTFE film.

All steel components of the modules mentioned are made of stainless steel.

1.2 Subject of permit

The subject of permit is the use of the 'Schöck Isokorb® T type S' modules in accordance with Section 1.1 for thermal separation of steel structures with simultaneous transmission of internal forces and moments between steel members with joints on both sides. An appropriate arrangement of the modules mentioned allows the transfer of moments. This decision covers the structural safety and fatigue verification under conditions of diurnal variation in thermal stress.

2 Provisions for the construction products**2.1 Properties and composition****2.1.1 Insulating elements**

The insulating elements of the modules listed in Section 1.1 consist of insulating materials in accordance with DIN EN 13163:2017-02 or DIN EN 13162:2015-04.

2.1.2 PTFE film

Each of the steel plates of the S-V modules is provided with a self-adhesive PTFE film on the outside. This film serves to reduce constraint forces under thermal stress. Detailed information on this film is deposited with DIBt.

2.1.3 Stainless steel components

All steel components of the S-N modules and S-V modules shall be produced from stainless steel in accordance with national technical approval no. Z-30.3-6 of 5 March 2018. Table 1 shows the material properties of the steel components.

The dimensions of the steel components shall correspond to the specifications given in the annexes to this approval and the documents deposited with DIBt.

Table 1: Material properties of the steel components

Component	Strength class	Material no. (group)
M16 threaded bars	70)*	1.4404 (A4L), 1.4571 (A5), 1.4362 (-)
M22 threaded bars	70)*	1.4404 (A4L), 1.4362 (-)
M16 or M22 hexagon nuts	70)*	1.4401 (A4), 1.4404 (A4L), 1.4571 (A5), 1.4362 (-)
Ø17 or Ø23 washers	50)*	1.4401 (A4), 1.4404 (A4L)
Hollow section SHS 50x50x3	S355	
Pressure plate	t = 12 mm	S275
	t = 10 mm	S355
Spacer plate t = 2 mm	S235	1.4401, 1.4404, 1.4571, 1.4362

)* material properties in accordance with DIN EN 1993-1-4:2015-10, Table 2.3

2.2 Manufacture and marking

2.2.1 Manufacture

The S-N modules and S-V modules shall be prefabricated at the manufacturing plant. The welding requirements in accordance with national technical approval no. Z-30.3-6 of 5 March 2018 shall be observed for the necessary welding work.

2.2.2 Marking

The manufacturer shall mark every packaging unit of the S-N modules and S-V modules from Schöck Bauteile GmbH in a durable and easily legible manner (e.g. using a suitable sticker) bearing the national conformity mark (*Ü-Zeichen*) in accordance with the Conformity Marking Ordinance (*Übereinstimmungszeichen-Verordnungen*) of the federal states. The mark shall only be applied if the requirements given in Section 2.3 'Confirmation of conformity' are met.

In addition, the marking shall include at least the following information:

- approval number 'Z-14.4-518',
- type designation for the respective module as given in Section 1.1 of this decision (e.g. 'Schöck Isokorb® T type S-N-D16').

Clear installation instructions shall be provided with each individual S-N module and S-V module. The manufacturer shall supply an installation manual with every delivery.

2.3 Confirmation of conformity

2.3.1 General

The manufacturer shall confirm for each manufacturing plant that the S-N modules and S-V modules comply with the provisions of the national technical approval included in this decision by way of a declaration of conformity based on factory production control and a certificate of conformity issued by a certification body recognised for these purposes as well as on regular external surveillance carried out by a recognised inspection body in accordance with the following provisions.

To issue the certificate of conformity and for external surveillance, including the associated product testing to be carried out in the process, the manufacturer of the S-N modules and S-V modules shall use an appropriately recognised certification body and an appropriately recognised inspection body.

The declaration of conformity shall be submitted by the manufacturer through marking of the construction product with the national conformity mark including statement of the intended use.

The certification body shall send a copy of the certificate of conformity issued by it to DIBt.

2.3.2 Factory production control

A factory production control system shall be set up and implemented in each manufacturing plant. Factory production control shall be understood to be continuous surveillance of production by the manufacturer to ensure that the manufactured construction products satisfy the provisions of the national technical approval included in this decision.

The following checks, verifications and inspections shall be carried out:

- Verification of the starting material and the components

Only materials for which the verification of conformity in accordance with the current standards and approvals has been provided and which are marked in a corresponding manner or which have been monitored and tested in accordance with the provisions of this national technical approval shall be used for the manufacture of the S-N modules and S-V modules.

The material properties stipulated in Section 2.1.3 of the steel components of the S-N modules and S-V modules shall be demonstrated with an inspection certificate 'type 3.1' in accordance with DIN EN 10204:2005-01. A declaration of compliance with the order 'type 2.1' in accordance with DIN EN 10204:2005-01 is required for the PTFE film described in Section 2.1.2. It is necessary to verify that the information in the declarations of compliance with the order is in agreement with the provisions of the national technical approval included in this decision.

- Checks and tests to be carried out during manufacture

The production steps necessary for assembling the S-N modules and S-V modules – especially the proper execution of the welded joints – shall be checked and monitored in accordance with the applicable Technical Building Rules.

- Verifications and tests to be carried out on the finished construction product:

The dimensions of the S-N modules and S-V modules, the correct assembly of the threaded bars and the fault-free execution and post-weld treatment of the welded joints shall be verified for every module.

The corrosion resistance specifications for the S-N modules and S-V modules (see Section 4) apply to the bare metal surfaces of the steel members. Compliance with this surface quality requirement for the metal components shall be verified through visual inspection of each module.

The results of factory production control shall be recorded and evaluated. The records shall at least include the following information:

- designation of the construction product or the starting material and the components,
- type of check or test,
- date of manufacture and testing of the construction product or the starting material or the components,
- results of the checks and tests as well as, if applicable, comparison with requirements,

- signature of the person responsible for factory production control.

The records shall be kept for at least five years and submitted to the inspection body used for external surveillance. They shall be submitted to DIBt and the competent supreme building authority upon request.

If the test result is unsatisfactory, the manufacturer shall immediately take the necessary measures to resolve the defect. Construction products which do not meet the requirements shall be handled in such a way that they cannot be confused with compliant products. After the defect has been remedied, the relevant test shall be repeated immediately, where technically feasible and necessary to show that the defect has been eliminated.

2.3.3 External surveillance

The factory production control system at each manufacturing plant shall be inspected regularly, i.e. at least twice a year, by means of external surveillance. Initial type-testing of the construction product shall be carried out within the scope of external surveillance. Samples for random testing shall also be taken. Sampling and testing shall be the responsibility of the recognised inspection body.

The results of certification and external surveillance shall be kept for at least five years. They shall be presented by the certification or inspection body to DIBt and the competent supreme building authority upon request.

3 Provisions for planning, design and execution

3.1 Planning and execution

The application of the S-N modules and S-V modules in accordance with Section 1.2 shall be planned taking into account the structural and building physical requirements.

The hole tolerance Δd of the joints in the end plate joints of the steel structure shall be executed in accordance with DIN EN 1993-1-8:2010-12 and shall be taken into account as a significant parameter in the fatigue verification (cf. Section 3.2.5).

The nuts of the threaded bars shall be tightened during installation with the following torque moments M. The threaded bars shall be peened to secure the nuts against loosening (see Figure 1).

- 'Schöck Isokorb® T type S-N-D16', 'Schöck Isokorb® T type S-V-D16': M = 50 Nm
- 'Schöck Isokorb® T type S-N-D22', 'Schöck Isokorb® T type S-V-D22': M = 80 Nm

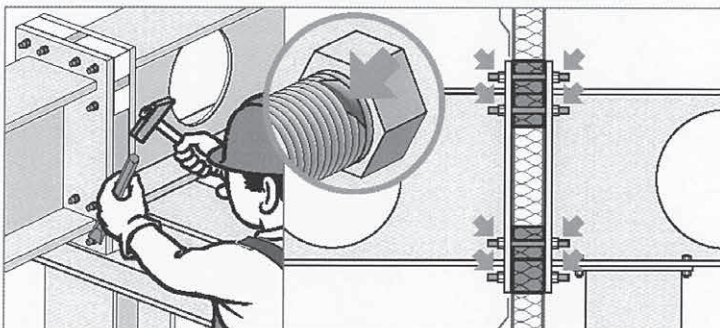

Figure 1: Peening the threaded bars to secure the position of the nuts

The vertical clearance between two modules may be 50 mm (minimum). For clearances less than 70 mm, the insulating elements of the modules may need to be reduced accordingly.

The S-N modules and S-V modules specified in the regulated configurations (see Annexes 4 to Annex 9, Annex 14 and Annex 15) shall be installed on site. The manufacturer shall supply an installation manual with every delivery to ensure proper installation.

The executing company shall provide a declaration of conformity in accordance with Sections 16a(5) and 21(2) of the Model Building Code to confirm the conformity of the execution of the joints using the S-N modules and S-V modules with the general construction technique permit included in this decision.

3.2 Design

3.2.1 General

The structural safety verification of the S-N modules and S-V modules shall be performed on the basis of the provisions of Section 3.2.2 using Annexes 4 to 15. Annexes 4 to 9 describe the joint configurations covered by this general construction technique permit. These annexes contain the following information:

- installation situation,
- transferable internal forces and moments,
- type of sections to be connected (Annexes 4 to 9 and 14 to 15)
- number of S-N modules and S-V modules to be used for each variant,
- arrangement of the modules (doubly symmetric with respect to the threaded bars, the section and the end plate; module arrangement as shown in the illustrations),
- specifications for determining the axial forces in the threaded bars.

Annexes 10 to 12 summarise the necessary calculations that shall be performed to verify the structural safety of the S-N modules and S-V modules. The various module arrangements shall be verified as follows:

- | | |
|---------------------------------|--|
| – configuration 'S-1-V' | verification in accordance with Annex 10 |
| – configuration 'S-1-N' | verification in accordance with Annex 11 |
| – configurations 'S-2' to 'S-5' | verification of S-N modules in accordance with Annex 11 and verification of S-V modules in accordance with Annex 12. |

Annex 13 can be used for dimensioning the end plates for I section joints. If no I sections are connected or if the geometric proportions lie outside the area of application of Annex 13, the end plates shall be verified on the basis of the introduced Technical Building Rules.

The regulations on the structural safety verification for pure shear force and for torsional stress and the fatigue verification are contained in Sections 3.2.3, 3.2.4 and 3.2.5.

3.2.2 Structural safety verification procedure

1) Determination of internal forces and moments

The module arrangements of the regulated configurations can transfer certain internal forces and moments which are calculated in accordance with Annexes 4 to 9. The forces and moments acting on the joint shall be determined on the basis of a calculation taking into consideration the entire system. Non-transferable internal forces and moments acting at the joint location shall be excluded from the structural system by positioning corresponding hinges. Otherwise, a rigid joint shall be assumed with respect to the transferable internal forces and moments on the safe side. For torsional stresses, see Section 3.2.4.

2) Stresses acting on the S-N modules and S-V modules

For the verification of the S-N modules and S-V modules, the stresses acting on the modules used shall be determined from the internal forces and moments determined in accordance with point 1. Axial forces in the threaded bars (TB) of the S-N modules and S-V modules shall be calculated from moments and axial forces in accordance with the specifications for the regulated configurations given in Annexes 4 to 9 using the following equation:

$$N_{TB,Ed} = \frac{M_{y,Ed}}{e_y} + \frac{M_{z,Ed}}{e_z} + \frac{N_{Ed}}{n}$$

When the internal forces and moments are inserted into the equations, the sign shall be chosen such that the sign of the axial force is negative with pushed/compressed threaded bars and positive when the threaded bars are pulled/under tension. The necessary characteristic values for calculating the threaded bar axial forces can be found in the respective annexes. For simple cases, merely the reduced equation for calculating the axial forces is given (configurations 'S-1-V' and 'S-1-N').

Shear forces can only be transferred via the S-V modules. The allocation of shear force components to the individual S-V modules in a joint configuration can be chosen freely as long as the following conditions are met:

- The applied shear force components V_z and V_y shall have the same proportion in all S-V modules (see Figure 2). Therefore, the following shall apply to all S-V modules:

$$V_{z,i,Ed} / V_{y,i,Ed} = \text{const.} \quad i = 1 \dots \text{number of S-V modules.}$$

- The distribution shall be symmetrical to the z axis.
- The sum of the shear force components of the individual S-V modules shall correspond to the total shear force acting on the joint location. The following shall apply:

$$\sum_i V_{z,i,Ed} = V_{z,Ed} \quad \text{and} \quad \sum_i V_{y,i,Ed} = V_{y,Ed}$$

$V_{z,i,Ed}$: shear force in the z direction of the i-th S-V module
 $V_{y,i,Ed}$: shear force in the y direction of the i-th S-V module.

If these conditions are met, the structural engineer may distribute the shear forces in accordance with the respective shear resistances of the S-V modules, which allows the shear resistance of the joint configuration to be maximised. It shall be made sure that any torsional moments arising from the misalignment in the shear force transfer (see Section 3.2.4) are safely transferred by the building. If the joint is primarily exposed to shear stress, see Section 3.2.3.

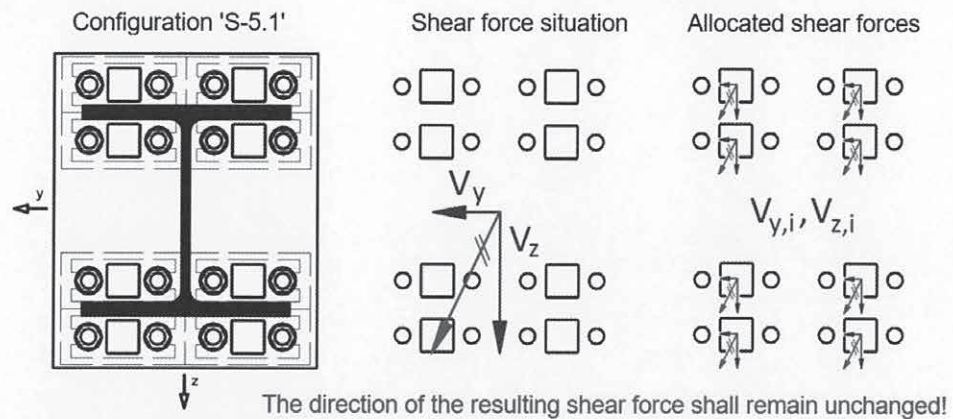

Figure 2: Principle of shear force allocation to the S-V modules of a joint

3) Structural safety verification

The structural safety verification shall be performed for each individual S-N module and S-V module in accordance with the specifications in Annex 10 (S-V module of variant 'S-1-V') or in Annexes 11 and 12 using the axial forces for the threaded bars of the modules and the shear force components (only S-V modules) determined in accordance with point 2.

3.2.3 Joint configurations primarily exposed to shear stress

If primarily shear stresses act on the joint, and the remaining stresses from moments and axial force effects are negligible, the verification shall be performed in accordance with Section 3.2.2. The special rules set out in Table 2 shall be observed. The joint configuration 'S-1-N' is not suitable for transferring shear forces.

Table 2: Special rules for joints primarily exposed to shear stress

Configuration	Shear resistance of S-V modules
S-1-V	in accordance with Annex 10, case 1
S-2, S-2.1	in accordance with Annex 12, case 1
S-3, S-3.1, S-4, S-4.1, S-5, S-5.1	When determining the shear resistance, the shear resistance for <u>one</u> of the S-V modules shall be calculated in accordance with Annex 12, case 1. For all other S-V modules, the shear resistance shall be determined in accordance with Annex 12, case 3.

3.2.4 Torsional stresses acting on the joint

The regulated joint configurations are not able to transfer torsional moments M_x . The entire structure shall therefore be designed in such a way that any torsional moments are otherwise safely transferred and do not cause any stresses at the joint location. Note: a misalignment of the shear force transfer (see Figure 3) may cause torsional moments acting on the joint if the end plate is not prevented from twisting around the longitudinal axis of the beam by the design of the structure.

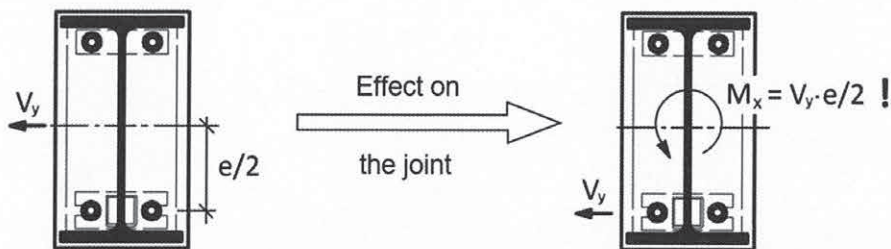

Figure 3: Torsional moment from misalignment of the shear force transfer (example using configuration 'S-2')

3.2.5 Verification of the fatigue due to temperature difference

Fatigue verifications under axial forces and bending of bar resulting from deformation due to temperature differences of the members to be connected are not necessary for the regulated configurations¹. These verifications are considered performed as part of the present construction technique permit, as the maximum influence lengths max L_E in the external members (see Figure 4) do not exceed the permissible influence lengths perm L_E :

$$\max L_E \leq \text{perm } L_E$$

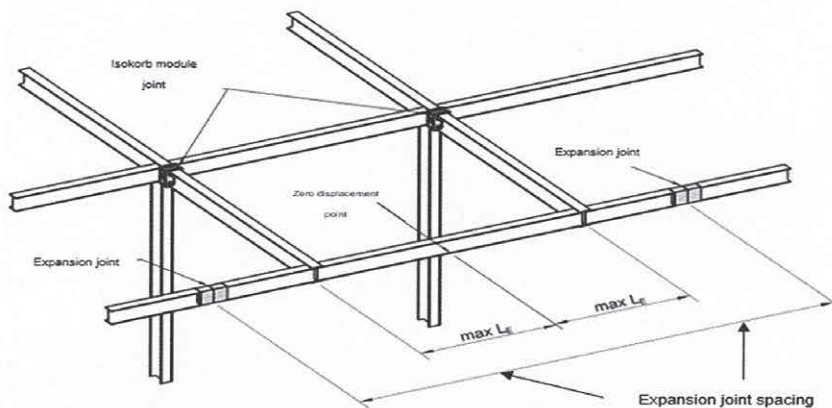

Figure 4: Maximum influence length

The maximum effective length is the greatest distance between an Isokorb® module joint and the associated zero displacement point under thermal stress in the area of a crossbeam. If the position of the zero displacement point cannot be determined visually, it shall be determined using appropriate modelling.

¹ The requirements in accordance with national technical approval no. Z-30.3-6 of 5 March 2018 Section 3.1, with reference to the regulations in DIN EN 1993-1-4/NA:2017-01 Section NCI to 8, are met with the verifications regulated in this decision. However, it was required in the permit process for the construction technique concerned that after the tests no resistance-reducing effect is identified (residual resistance 100%). This is a deviation from the 80% residual resistance requirement pursuant to DIN EN 1993-1-4/NA.

National technical approval /
 General construction technique permit
 No. Z-14.4-518

Page 11 of 11 | 21 October 2019

If different joint configurations are combined in the area of a crossbeam, the stiffness differences between the individual joints shall be taken into account. If expansion joints are placed in the crossbeams, these shall safely and permanently permit temperature-induced displacements of the crossbeam ends without hindrance.

The permissible influence lengths depending on the nominal hole tolerance of the end plate joint of the steel structure can be found in Table 3.

Table 3: Permissible influence lengths

Nominal hole tolerance Δd of the end plate joint of the steel structure	perm L_E
≥ 0.3 mm	2.50 m
≥ 0.6 mm	3.00 m
≥ 1.0 mm	3.67 m
≥ 1.8 mm	5.00 m
= 2.0 mm	5.24 m

The permissible influence lengths given in Table 3 only apply if the coefficient of friction between the S-V modules and the connected members is not greater than 0.08. This requirement is met if a self-adhesive PTFE film (see Section 2.1.2) is placed on the S-V modules or on the connected member in the joint area for each assembly joint. The unlaminated frictional surface of the assembly joint in connection with the PTFE film shall have at least the frictional properties of an uncoated steel surface (surface roughness: the average roughness value R_a shall not exceed $0.6 \mu\text{m}$). If this cannot be ensured, both frictional surfaces shall be provided with self-adhesive PTFE film. The instructions for applying the PTFE film in the manufacturer's installation guide shall be followed.

4 Provisions for use, maintenance and repair

The corrosion stresses acting on the S-N modules and S-V modules during use, depending on the steel grade (see Table 1), shall not exceed the critical corrosion of corrosion resistance class III in accordance with national technical approval no. Z-30.3-6 of 5 March 2018. The steel grade requirements of the respective corrosion resistance class shall be met by all steel components connected to a module.

Andreas Schult
 Head of Section

Drawn up by

S-N modules

Schöck Isokorb® T type S-N-D16

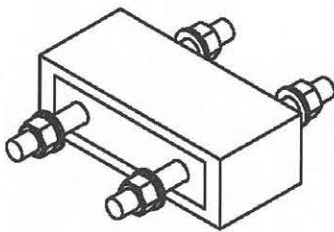

Schöck Isokorb® T type S-N-D22

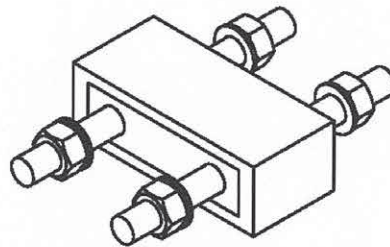

S-V modules

Schöck Isokorb® T type S-V-D16

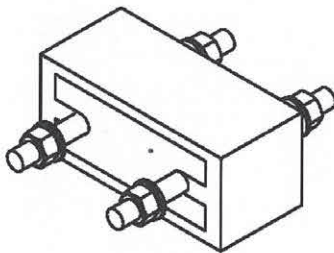

Schöck Isokorb® T type S-V-D22

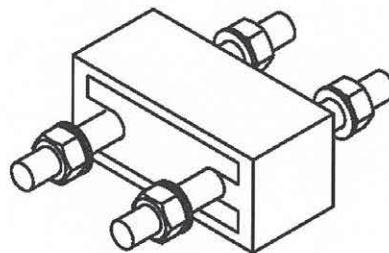

Schöck Isokorb® T Type S for joints in steel structures

S-N modules and S-V modules

Annex 1

Schöck Isokorb® T type S-N-D16

Sectional view:

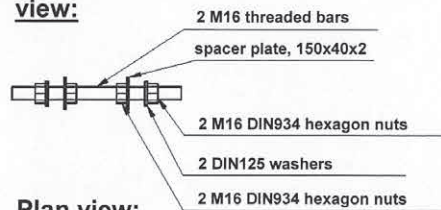

Plan view:

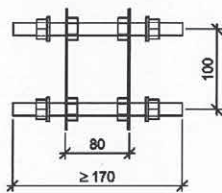

Side view:

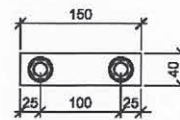

Isometric view:

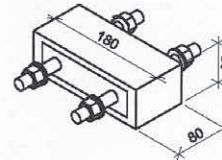

Schöck Isokorb® T type S-N-D22

Sectional view:

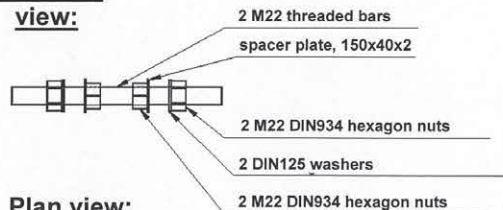

Plan view:

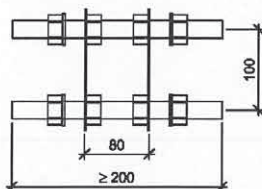

Side view:

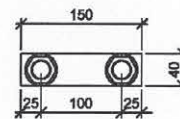

Isometric view:

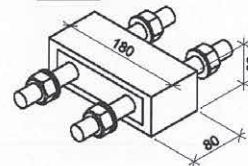

Here width of insulating element, for example, 180 mm (required minimum dimension 150 mm)

Schöck Isokorb® T Type S for joints in steel structures

Design and dimensions of S-N modules

Annex 2

Schöck Isokorb® T type S-V-D16

Sectional view:

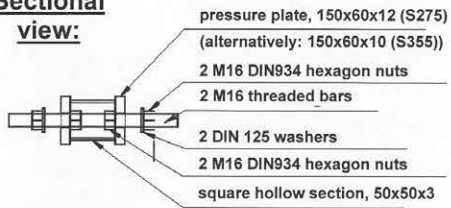

Plan view:

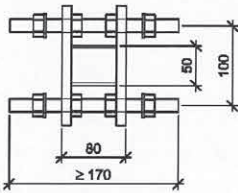

Side view:

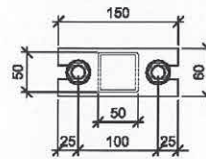

Isometric view:

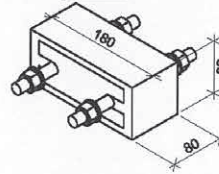

Schöck Isokorb® T type S-V-D22

Sectional view:

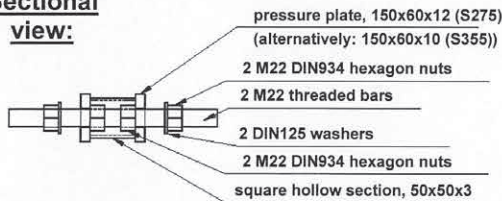

Plan view:

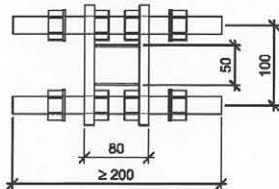

Side view:

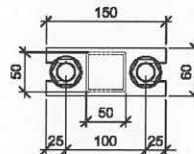

Isometric view:

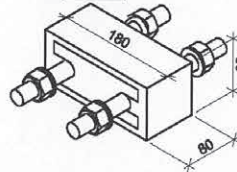

Here width of insulating element, for example, 180 mm (required minimum dimension 150 mm)

Schöck Isokorb® T Type S for joints in steel structures

Design and dimensions of S-V modules

Annex 3

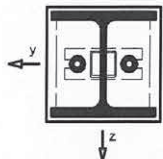
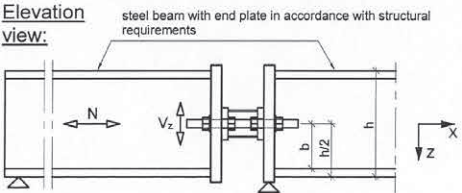
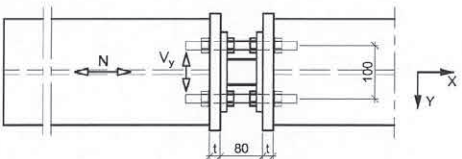
	I section joint	Configuration: S-1-V
	Installation situation:	for supported steel structures and rigid joints on both sides of the end plates of the steel structure
	Transferable internal forces and moments: N, V_z, V_y	[kN]
<p>Module type and number:</p> <ul style="list-style-type: none"> • 1 x Schöck Isokorb® T type S-V-D16 or • 1 x Schöck Isokorb® T type S-V-D22 		
<p><u>Elevation view:</u></p>  <p>steel beam with end plate in accordance with structural requirements</p> <p><u>Plan view:</u></p>  <p>(shown without thermal insulation)</p>		<p>Axial forces in threaded bars (TB):</p> $N_{TB,Ed} = \frac{N_{Ed}}{2}$ <p>The correct sign must be used for the internal forces and moments when inserted into the equation (TB pulled / in tension, N_{TB} positive; TB pushed / in compression, N_{TB} negative).</p>
Schöck Isokorb® T Type S for joints in steel structures		Annex 4
I section joint, configuration 'S-1-V'		

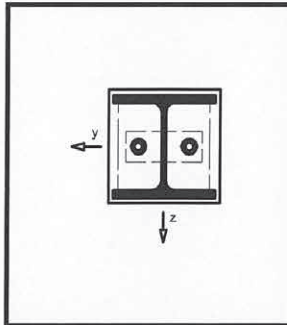

I section joint

Configuration: **S-1-N**

Installation situation:

for installation situations requiring pure axial force transfer; other loads are to be excluded

Transferable internal forces and moments:

$$N \text{ [kN]}$$

Module type and number:

- 1 x Schöck Isokorb® T type S-N-D16 or
- 1 x Schöck Isokorb® T type S-N-D22

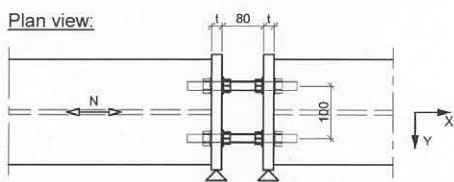
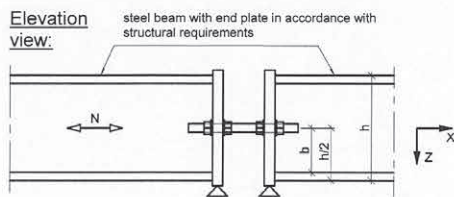

(shown without thermal insulation)

Axial forces in threaded bars (TB):

$$N_{Tb,Ed} = \frac{N_{Ed}}{2}$$

The correct sign must be used for the internal forces and moments when inserted into the equation (TB pulled / in tension, N_{TB} positive; TB pushed / in compression, N_{TB} negative).

Schöck Isokorb® T Type S for joints in steel structures

I section joint, configuration 'S-1-N'

Annex 5

	I section joint	Configuration: S-2
	Installation situation:	supported and cantilevered steel structures
	Transferable internal forces and moments: N, V_z, V_y, M_y, M_z	[kN, kNcm]
<p>Module type and number:</p> <ul style="list-style-type: none"> • 1 x Schöck Isokorb® T type S-N-D16 and 1 x Schöck Isokorb® T type S-V-D16 or • 1 x Schöck Isokorb® T type S-N-D22 and 1 x Schöck Isokorb® T type S-V-D22 <p>Mixed use of D16 and D22 modules is not permissible!</p>		
<p>Elevation view:</p> <p>steel beam with end plate in accordance with structural requirements</p> <p>Plan view:</p> <p>(shown without thermal insulation)</p>		<p>Axial forces in threaded bars (TB):</p> $N_{TB,Ed} = \frac{M_{y,Ed}}{e_y} + \frac{M_{z,Ed}}{e_z} + \frac{N_{Ed}}{n}$ <p>It must be ensured that, for the threaded bar under consideration, the correct sign is used for the internal forces and moments when inserted into the equation (TB pulled / in tension, N_{TB} positive; TB pushed / in compression, N_{TB} negative).</p> <p>Characteristic values to be used:</p> $e_y = 2 \cdot e \quad [\text{cm}]$ $e_z = 2 \cdot 10 = 20 \quad [\text{cm}]$ $n = 4 \quad [-]$
Schöck Isokorb® T Type S for joints in steel structures		Annex 6
I section joint, configuration 'S-2'		

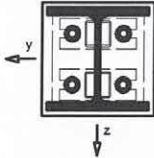
	I section joint	Configuration: S-3
	Installation situation:	supported and cantilevered steel structures
	Transferable internal forces and moments: N, V_z, V_y, M_y, M_z	[kN, kNcm]

Module type and number:

- 2 x Schöck Isokorb® T type S-V-D16 or
- 2 x Schöck Isokorb® T type S-V-D22

Mixed use of D16 and D22 modules is not permissible!

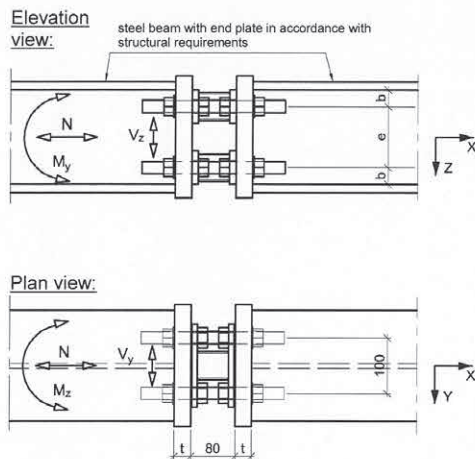

(shown without thermal insulation)

Axial forces in threaded bars (TB):

$$N_{TB,Ed} = \frac{M_{y,Ed}}{e_y} + \frac{M_{z,Ed}}{e_z} + \frac{N_{Ed}}{n}$$

It must be ensured that, for the threaded bar under consideration, the correct sign is used for the internal forces and moments when inserted into the equation (TB pulled / in tension, N_{TB} positive; TB pushed / in compression, N_{TB} negative).

Characteristic values to be used:

$$e_y = 2 \cdot e \quad [\text{cm}]$$

$$e_z = 2 \cdot 10 = 20 \quad [\text{cm}]$$

$$n = 4 \quad [-]$$

Schöck Isokorb® T Type S for joints in steel structures

I section joint, configuration 'S-3'

Annex 7

	<p>I section joint</p>	<p>Configuration: S-4</p>
	<p>Installation situation:</p>	<p>supported and cantilevered steel structures</p>
	<p>Transferable internal forces and moments: N, V_z, V_y, M_y, M_z</p>	<p>[kN, kNcm]</p>
<p>Module type and number:</p> <ul style="list-style-type: none"> • 4 x Schöck Isokorb® T type S-V-D16 or • 4 x Schöck Isokorb® T type S-V-D22 <p>Mixed use of D16 and D22 modules is not permissible!</p>		
<p><u>Elevation view:</u></p>	<p>Axial forces in threaded bars (TB):</p> $N_{TB,Ed} = \frac{M_{y,Ed}}{e_y} + \frac{M_{z,Ed}}{e_z} + \frac{N_{Ed}}{n}$ <p>It must be ensured that, for the threaded bar under consideration, the correct sign is used for the internal forces and moments when inserted into the equation (TB pulled / in tension, N_{TB} positive; TB pushed / in compression, N_{TB} negative).</p>	
<p><u>Plan view:</u></p>	<p>Characteristic values to be used:</p> $e_y = 4 \cdot \frac{z_1^2 + z_2^2}{z_i} \quad [\text{cm}] \quad i = 1 \dots 2$ <p>The distance z_i shall be inserted corresponding to the threaded bar under consideration.</p> $e_z = 4 \cdot 10 = 40 \quad [\text{cm}]$ $n = 8 \quad [-]$	
<p>(shown without thermal insulation)</p>		
<p>Schöck Isokorb® T Type S for joints in steel structures</p>		
<p>I section joint, configuration 'S-4'</p>		<p>Annex 8</p>

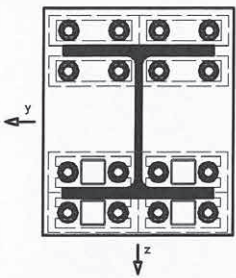
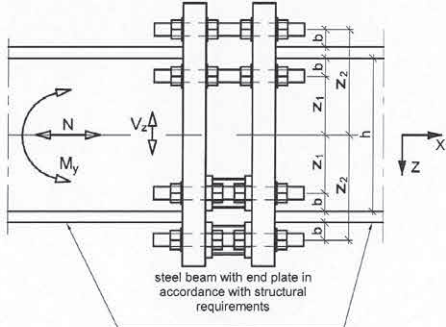
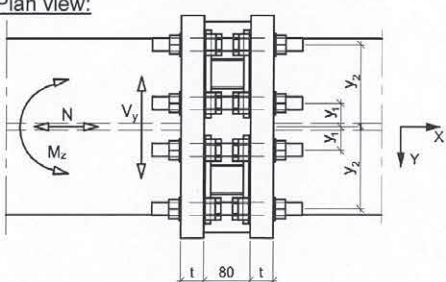
	<p>I section joint</p>	<p>Configuration: S-5</p>
<p>Installation situation:</p>		<p>supported and cantilevered steel structures</p>
<p>Transferable internal forces and moments: N, V_z, V_y, M_y, M_z</p>		<p>[kN, kNcm]</p>
<p>Module type and number:</p> <ul style="list-style-type: none"> • 4 x Schöck Isokorb® T type S-N-D16 and 4 x Schöck Isokorb® T type S-V-D16 or • 4 x Schöck Isokorb® T type S-N-D22 and 4 x Schöck Isokorb® T type S-V-D22 <p>Mixed use of D16 and D22 modules is not permissible!</p>		
<p><u>Elevation view:</u></p>  <p><u>Plan view:</u></p>  <p>(shown without thermal insulation)</p>	<p>Axial forces in threaded bars (TB):</p> $N_{TB,Ed} = \frac{M_{y,Ed}}{e_y} + \frac{M_{z,Ed}}{e_z} + \frac{N_{Ed}}{n}$ <p>It must be ensured that, for the threaded bar under consideration, the correct sign is used for the internal forces and moments when inserted into the equation (TB pulled / in tension, N_{TB} positive; TB pushed / in compression, N_{TB} negative).</p> <p>Characteristic values to be used:</p> $e_y = 8 \cdot \frac{z_1^2 + z_2^2}{z_l} \quad [\text{cm}] \quad i = 1 \dots 2$ $e_z = 8 \cdot \frac{y_1^2 + y_2^2}{y_j} \quad [\text{cm}] \quad j = 1 \dots 2$ <p>The distances z_i and y_j shall be inserted corresponding to the threaded bar under consideration.</p> $n = 16 \quad [-]$	
<p>Schöck Isokorb® T Type S for joints in steel structures</p>		<p>Annex 9</p>
<p>I section joint, configuration 'S-5'</p>		

Translation authorised by DIBt

Verification of S-V module configuration 'S-1-V'

Please note: The configuration 'S-1-V' in accordance with Annex 4 is only permissible for supported steel structures and for moment rigid joints on both sides of the end plates of the steel structure.

I) Module-specific parameters	Normal force per threaded bar		Shear force S-V module	
	$C_{N,Rd}$	$C_{Z,Ed}$	$C_{V,Rd}$	$C_{V,y,Rd}$
Schöck Isokorb® T type S-V-D16	58.4 kN	13.4 kN	30.0 kN	6.0 kN
Schöck Isokorb® T type S-V-D22	112.7 kN	58.7 kN	36.0 kN	
II) Stress acting on the components of the S-V module				
	Case 1 (tension only)		Case 2 (compression only)	
- Threaded bars:	$Z_{Ed} = N_{TB,Ed}$		$D_{Ed} = N_{TB,Ed} $	
- S-V module:	$V_{y,Ed}$ and $V_{z,Ed}$			
III) Resistances of the components of the S-V module				
- Normal force per threaded bar:	$N_{Rd} = C_{N,Rd}$			
- Shear force S-V module:	$Z_{Ed} \leq C_{Z,Ed} \Rightarrow V_{Rd} = C_{V,Rd}$		$V_{Rd} = C_{V,Rd}$	
	$C_{Z,Ed} < Z_{Ed} \leq N_{Rd} \Rightarrow V_{Rd} = \frac{2}{3} \cdot (N_{Rd} - Z_{Ed})$			
	$V_{y,Rd} = C_{V,Rd} / 2$		$V_{y,Rd} = C_{V,y,Rd}$	
IV) Verification of the S-V module				
- Threaded bars:	$Z_{Ed} \leq N_{Rd}$		$D_{Ed} \leq N_{Rd}$	
- S-V module:	Case 1: $ V_{y,Ed} + V_{z,Ed} \leq V_{Rd}$ and $ V_{y,Ed} \leq V_{y,Rd}$		Case 2: $ V_{y,Ed} \leq V_{y,Rd} \Rightarrow V_{z,Ed} \leq V_{Rd}$ $V_{y,Rd} < V_{y,Ed} \leq V_{Rd} / 2 \Rightarrow V_{y,Ed} + V_{z,Ed} \leq V_{Rd}$	

Schöck Isokorb® T Type S for joints in steel structures

Verification of S-V module variant 'S-1-V'

Annex 10

Verification of S-N modules

Please note: S-N modules are not suitable for transferring shear forces.

I) Module-specific parameters	Normal force per threaded bar		
	$C_{Z,Rd}$	$C_{D,Rd}$	
Schöck Isokorb® T type S-N-D16	58.4 kN	31.7 kN	
Schöck Isokorb® T type S-N-D22	112.7 kN	74.8 kN	
II) Stress acting on the components of the S-N module			
	Case 1 (tension only)	Case 2 (tension and compression)	Case 3 (compression only)
- Threaded bars:	$Z_{Ed} = \max(N_{TB,Ed})$	$N_{TB}^{tension}: Z_{Ed} = N_{TB,Ed}$ $N_{TB}^{comp}: D_{Ed} = N_{TB,Ed} $	$D_{Ed} = \max(N_{TB,Ed})$
III) Resistances of the components of the S-N module			
- Normal force per threaded bar:	$Z_{Rd} = C_{Z,Rd}$ and $D_{Rd} = C_{D,Rd}$		
IV) Verification of the S-N module			
	$Z_{Ed} \leq Z_{Rd}$ and $D_{Ed} \leq D_{Rd}$		
- Threaded bars:	<p>If there are acting moments M_z, the following must also be shown:</p> <p>- e_z, n: characteristic values for the respective configurations given in Annexes 5 to 9</p> <p>- $M_{z,Ed}, N_{Ed}$: internal forces and moments acting on the Isokorb</p> $\frac{ M_{z,Ed} }{e_z} + \frac{N_{Ed}}{n} \leq \frac{C_{Z,Rd}}{2}$		

Schöck Isokorb® T Type S for joints in steel structures

Verification of S-N modules

Annex 11

Verification of S-V modules excluding configuration 'S-1-V'

Please note: The following verifications do **not** apply to the configuration 'S-1-V'. Verification of the configuration 'S-1-V' shall be provided in accordance with Annex 10.

I) Module-specific parameters	Normal force per threaded bar		Shear force per S-V module	
	$C_{N,Rd}$	$C_{ZD,Ed}$	$C_{VZ,Rd}$	$C_{VD,Rd}$
Schöck Isokorb® T type S-V-D16	58.4 kN	13.4 kN	30.0 kN	46.0 kN
Schöck Isokorb® T type S-V-D22	112.7 kN	58.7 kN	36.0 kN	50.0 kN
II) Stresses acting on the components of the S-V module				
	<i>Case 1</i> (tension only)	<i>Case 2</i> (tension and compression)	<i>Case 3</i> (compression only)	
- Threaded bars:	$Z_{Ed} = \max(N_{TB,Ed})$	$N_{TB}^{tension}: Z_{Ed} = N_{TB,Ed}$ $N_{TB}^{compr.}: D_{Ed} = N_{TB,Ed} $	$D_{Ed} = \max(N_{TB,Ed})$	
- S-V module:	$V_{y,i,Ed}$ and $V_{z,i,Ed}$ (S-V components of total shear force acting on joint)			
III) Resistances of the components of the S-V module				
- Normal force per threaded bar:	$N_{Rd} = C_{N,Rd}$			
- Shear force per S-V module:	$Z_{Ed} \leq C_{ZD,Ed} \Rightarrow V_{Rd} = C_{VZ,Rd}$ $C_{ZD,Ed} < Z_{Ed} \leq N_{Rd} \Rightarrow V_{Rd} = \frac{2}{3} \cdot (N_{Rd} - Z_{Ed})$		Case 3: $V_{Rd} = C_{VD,Rd}$	
	$V_{y,Rd} = C_{VD,Rd} / 2$			
IV) Verification of the S-V module				
	$Z_{Ed} \leq N_{Rd}$ and $D_{Ed} \leq N_{Rd}$			
- Threaded bars:	If there are acting moments M_z , the following must also be shown: - e_z, n : characteristic values for the respective configurations given in Annexes 5 to 9 - $M_{z,Ed}, N_{Ed}$: internal forces and moments acting on the Isokorb $\frac{ M_{z,Ed} }{e_z} + \frac{N_{Ed}}{n} \leq \frac{C_{N,Rd}}{2}$			
- S-V module:	$ V_{y,i,Ed} + V_{z,i,Ed} \leq V_{Rd}$ and $ V_{y,i,Ed} \leq V_{y,Rd}$			

Schöck Isokorb® T Type S for joints in steel structures

Verification of S-V modules excluding configuration 'S-1-V'

Annex 12

Minimum thickness of the end plates of the steel structure without more detailed verification

Prerequisites:

- Joint is an I section joint.
- Joint configuration corresponds to specifications of this approval.
- Steel grade of end plates is S235 or higher.
- All threaded bars lie within the flange width b_2 (see sketch below).

Input parameters for the following tables:

- Z_{Ed} : force in the threaded bar with the highest tensile stress
- b : maximum distance from threaded bar axis to beam flange edge
- b_2 : beam width or end plate width. The smaller value is relevant.

Example: I section joint configuration 'S-5' (for other configurations see Annexes 4 to 8)

Front view:

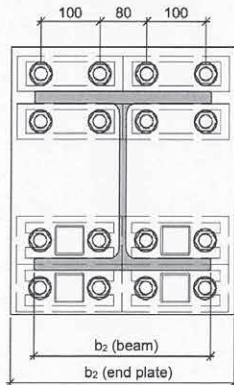

Side view:

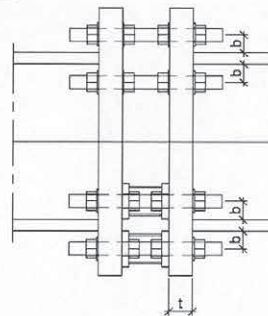

Required minimum thickness of end plate t_{min} in mm:

D16 modules	$Z_{Rd} = 58.4 \text{ kN}$	
Area of application: $b \leq 35 \text{ mm}$ $b_2 \geq 150 \text{ mm}$	Z_{Ed} / Z_{Rd}	t_{min}
	1.00	25
	0.80	20
	0.45	15

D22 modules	$Z_{Rd} = 112.7 \text{ kN}$	
Area of application: $b \leq 50 \text{ mm}$ $b_2 \geq 200 \text{ mm}$	Z_{Ed} / Z_{Rd}	t_{min}
	1.00	35
	0.80	30
	0.50	25

If the above prerequisites have not been met or if the geometric conditions lie outside the area of application, structural verification must be provided for the end plate.

Minimum spacing in accordance with DIN EN 1993-1-8:2010-12 shall be observed.

Schöck Isokorb® T Type S for joints in steel structures

Required minimum thickness of the end plates of the steel structure without more detailed verification of the I section joints

Annex 13

Alternative joint configurations for I section joints

The following alternatives to the standard joint configurations 'S-2' to 'S-5' are permissible and can be verified in accordance with Annexes 11 to 13. The details in the associated variant-describing Annexes 6 to 9 shall be applied accordingly.

Configuration 'S-2.1' to be handled as per Annex 6

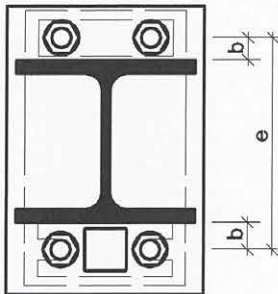

External module arrangement

Configuration 'S-3.1' to be handled as per Annex 7

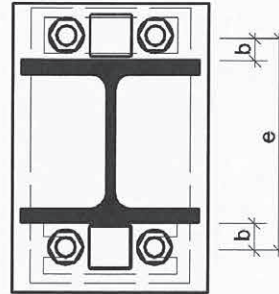

External module arrangement

Configuration 'S-4.1' to be handled as per Annex 8

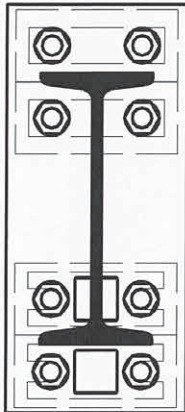

2 x Schöck Isokorb® T type S-N-D16 and
2 x Schöck Isokorb® T type S-V-D16 or
2 x Schöck Isokorb® T type S-N-D22 and
2 x Schöck Isokorb® T type S-V-D22

Configuration 'S-5.1' to be handled as per Annex 9

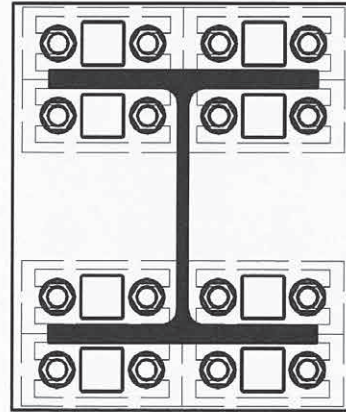

8 x Schöck Isokorb® T type S-V-D16 or
8 x Schöck Isokorb® T type S-V-D22

Schöck Isokorb® T Type S for joints in steel structures

Possible alternative joint configurations for I section joints

Annex 14

Joints for other doubly symmetric sections

This decision generally regulates joints for I sections. Joints for other doubly symmetric sections are permissible provided that the following specifications are observed.

a) Prerequisites for other section type joints:

- The cross-sectional shape of the section to be connected be doubly symmetric (see the following possible configuration with a module arrangement as in configuration 'S-2').

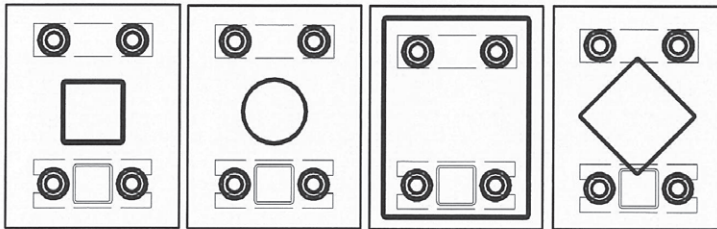

- The type, arrangement and orientation of the S-N modules and S-V modules of the joint must correspond to a configuration in accordance with Annexes 4 to 9 or Annex 14.
- The joint configuration must be doubly symmetric in terms of the threaded bar arrangement, the profile cross section and the end plate.
- With a multi-row module arrangement, the distance from one threaded bar to the nearest cross-section area must not be greater than the distance to the nearest threaded bar (see the following figure a with module arrangement as in configuration 'S-5').

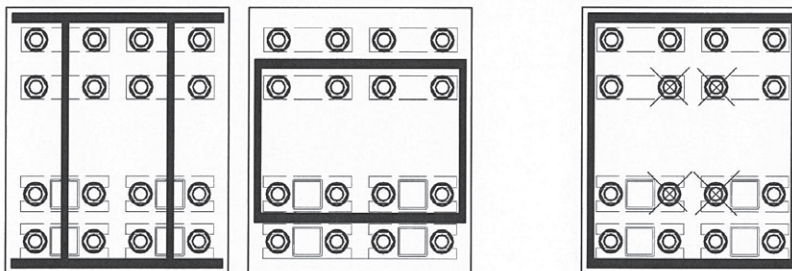

permissible joint configurations

not permissible

- Safe installation of the S-N modules and S-V modules must be possible (e.g. the arrangement of mounting holes in the box section shown above).

b) Verification

The regulations for I section joints shall be applied accordingly.

c) Dimensioning of end plates

The end plates shall be verified and dimensioned on the basis of introduced Technical Building Rules. Dimensioning based on Annex 13 is not permissible.

Schöck Isokorb® T Type S for joints in steel structures

Joints for other doubly symmetric sections

Annex 15

Technické změny vyhrazeny.
Datum vydání: Červen 2020

Schöck-Wittek s.r.o.
Veslavínova 8
746 01 Opava
Tel.: 553 788 308
Fax: 553 788 308
wittek@wittek.cz
www.schoeck-wittek.cz

 **Schöck**
Stavíme na spolehlivosti