



Thermally separated reinforced concrete walls.
Schöck Alphadock® wall connections.

Less energy loss, enhanced planning scope.

Optimum thermal insulation and maximum load bearing capacity.

Too important to be overlooked.

Until now, linear thermal bridges at reinforced concrete walls were often neglected – and the resulting energy loss simply compensated arithmetically. In the case of building envelopes with thick thermal insulation and modern heating and ventilation strategies, however, the negative effect of linear thermal bridges can be greatly exacerbated, and can be responsible for as much as 25 percent of the total energy loss. Planners should aim to optimise this weak point. After all, property owners can be eligible for subsidies by complying with a stricter energy standard – and can therefore reap financial benefit. Conventional solutions are scarcely able to achieve this, particularly in the case of larger buildings with stricter requirements in respect of structural stability.

Appreciated by architects and structural engineers alike:

- ▶ Alphadock® reduces the effect of those thermal bridges that architects and structural engineers always thought were unavoidable.
- ▶ Alphadock® enables the design of large buildings with high static loads that adhere to the strictest energy saving standards.
- ▶ Alphadock® reduces the energy requirement of a building enormously.
- ▶ Alphadock® enhances an architect's planning scope by eliminating the need for designs that compensate energy losses.
- ▶ Alphadock® improves the quality of living and room climate by avoiding cold parts in the interior of a building.
- ▶ Alphadock® mitigates the risk of construction damage caused by mould and condensation, if installed properly.

Appreciated by construction engineers as well:

- ▶ Alphadock® is easy to install and saves time (less handling required compared to parapet connections).
- ▶ The need for less insulation beneath ceilings saves (installation) time and money.

Attracts the attention of engineers:

- ▶ Alphadock® enables the construction of multi-storey, efficiently insulated buildings with high static loads.
- ▶ Unlike walls that are concreted through, Alphadock® easily complies with the requirements of SIA 180 «Thermal insulation, humidity control and room climates in buildings» (wall surface temperature) even when the reinforced concrete walls are exposed to severe loads.
- ▶ Alphadock® solutions are easy to calculate using a simple structural principle.
- ▶ Alphadock® is also suitable for column connections (subject to consultation with our team of advisers).

Benefits property owners:

- ▶ Alphadock® saves energy, reduces emissions and considerably lowers the operating cost of a building.
- ▶ Alphadock® minimises thermal bridges, thus eliminating the risk of mould growth. Construction damage and renovation costs are effectively prevented.
- ▶ Alphadock® enhances the value in use of various rooms and has a positive effect on the living climate.
- ▶ When planning low-energy and Minergie-compliant houses, the design constraints or restrictions on use are minimised.
- ▶ Reducing the thickness of the exterior insulation perimeter increases the usable space (subject to canton-specific building codes). Which more than compensates the costs of Alphadock®.
- ▶ The cost of an Alphadock® solution is more than compensated by the savings on technical building equipment (e.g. smaller heating systems).

Delights environmentally- and cost-conscious residents:

- ▶ CO2 emissions are considerably lower, as is the heating bill.

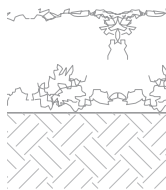

Thermal bridges in reinforced concrete wall connections cause huge energy losses and make it difficult to comply with the highest energy standards in new buildings. Added to which, structural damage caused by condensation or mould is not rare. While seamless thermal insulation of the building envelope might enable huge energy savings, it is difficult to achieve, given the structural requirements of reinforced concrete walls. Schöck Alphadock® is a thermally insulating wall connection that combines outstanding insulation performance with maximum load bearing capability.

Possible placement of Schöck Alphadock®.

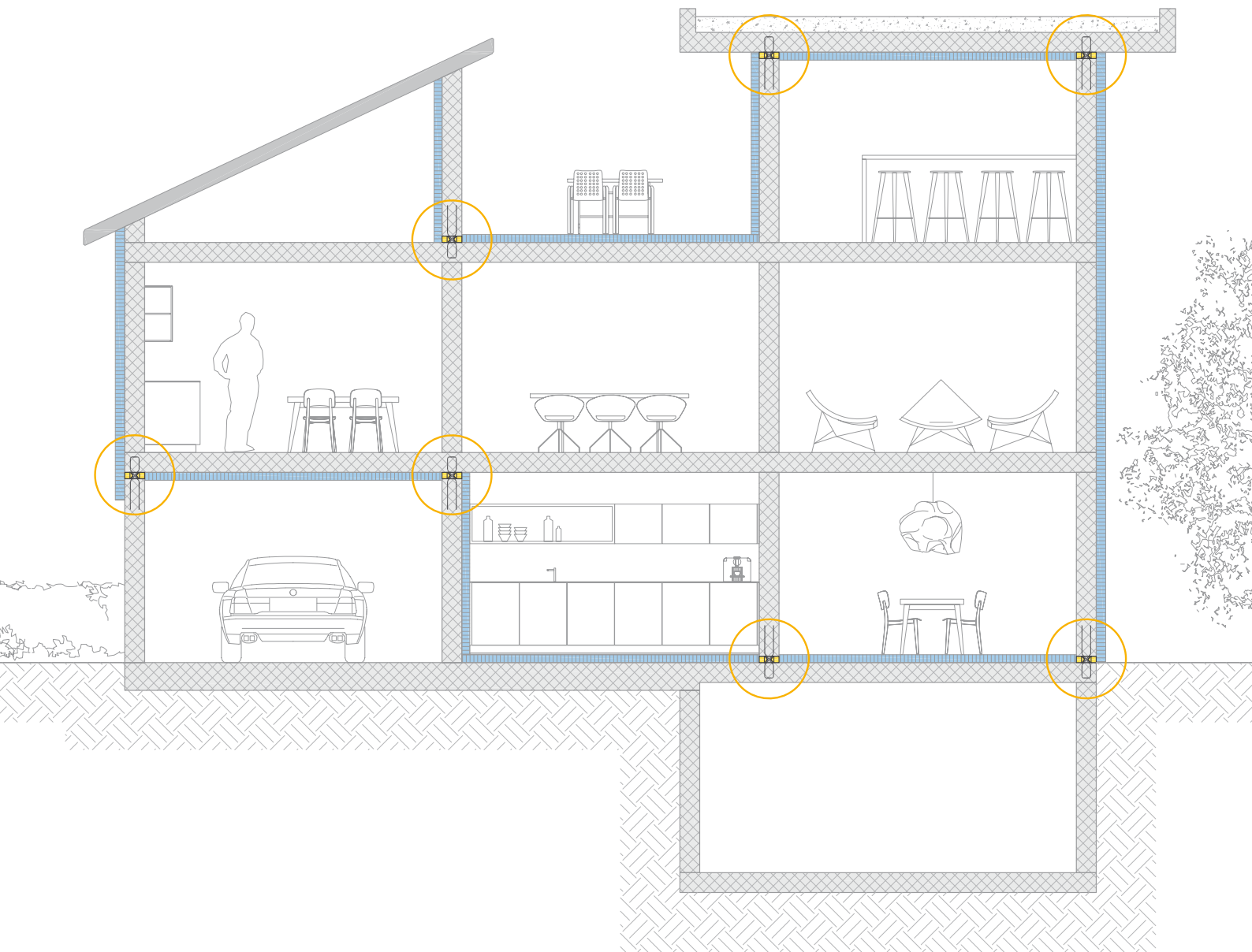

Thermographic representation.

Convincing at first sight.

Reducing thermal bridges

Heating buildings accounts for a third of the total energy used in Switzerland. In turn, thermal bridges on buildings cause as much as 25 percent of this heating energy to be wasted. Reducing thermal bridges therefore offers much more savings potential than assumed by many experts. The following thermographic images are impressive testament to the effective minimisation of thermal bridges through the use of Schöck Alphadock®.

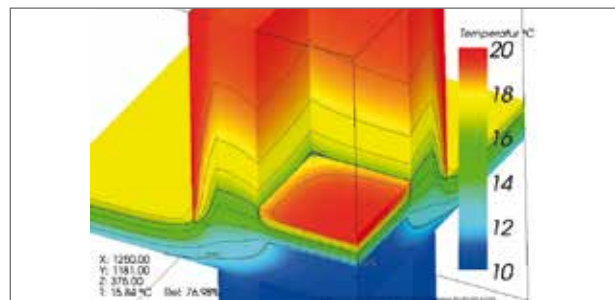
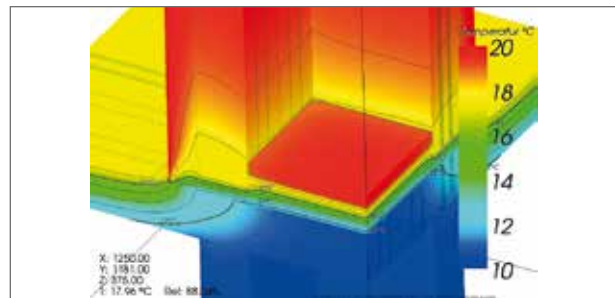

Wall corner on garage ceiling slab.

Upper image with Alphadock®, lower image without Alphadock®.

Wall connection to floor slab, thermally separated

Schöck Alphadock® minimises the thermal bridge between the exterior wall insulation and the insulation above the floor slab. Thermal losses are greatly reduced and the surface temperature in the room increases to considerably more than the critical dew point temperature. Heating costs are lower, a pleasant room climate is created, and the PSI of the connected reinforced concrete wall is reduced by up to 90 percent.

Schöck Alphadock® offers the following advantages compared to a foam glass solution beneath the floor slab: Insulation on the floor slab allows the best possible use to be made of the strength and rigidity of the substrate. New design options are created by the compression surface and/or continuous compression force beneath the walls. A further benefit lies in the generally enormously reduced cost compared to insulation beneath the floor slab.

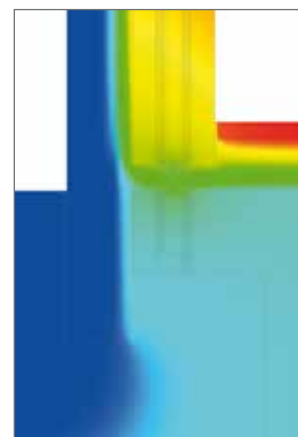
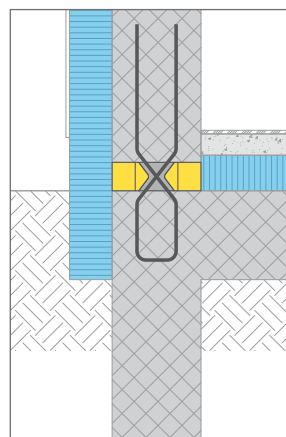

Wall connection to floor slab:

Surface temperature inside the room $\theta_{si} = 16.2 \text{ °C}$
Temperature factor $f_{Rsi} = 0.87$

Thermal insulation in wall connection on/beneath ceiling

One of the most frequent linear thermal bridges occurs at the transition from cold basement areas to warm parts of a building. Using Schöck Alphadock® enables continuous and efficient thermal insulation of the reinforced concrete walls that penetrate the insulation perimeter. Thermal losses and heating costs are reduced, the risk of condensate accumulating and mould forming is ruled out, and a healthy room climate is created.

By comparison: The PSI of the connected wall decreases from its uninsulated state of $0.98 \text{ W}/(\text{m}\cdot\text{K})$ by a factor of 3 – 10 to $0.10 - 0.25 \text{ W}/(\text{m}\cdot\text{K})$ (see also top of page 6).

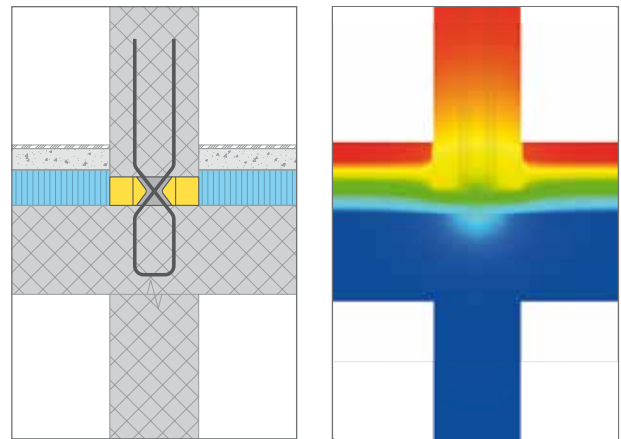

Wall connection to ceiling:

Surface temperature inside the room $\theta_{si} = 18.1 \text{ }^\circ\text{C}$

Temperature factor $f_{Rsi} = 0.81$

Thermal insulation in timber construction

Schöck Alphadock® reduces the thermal bridge between the exterior wall insulation and the insulation beneath the cellar ceiling. The rising cold in the cellar wall is continuously and effectively thermally insulated with Schöck Alphadock®. The surface temperature of the cellar ceiling rises and prevents the accumulation of condensate and associated damage to the timber structure.

The service life of the façade is extended greatly and the need for costly renovation of moisture-related damages is eliminated. In addition, the heating bill is lower as a result of the reduced thermal losses, and the room climate is better.

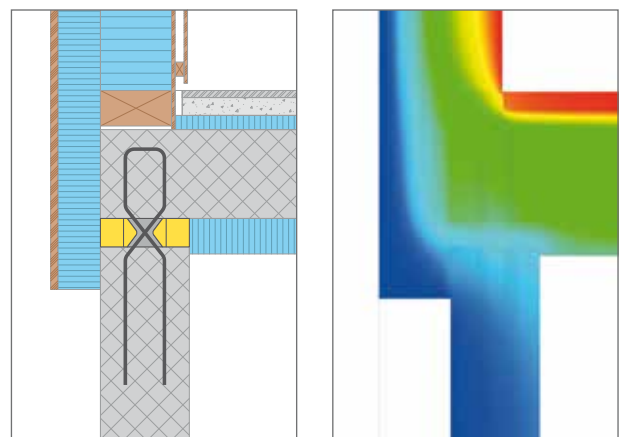

Timber construction:

Surface temperature inside the room $\theta_{si} = 16.8 \text{ }^\circ\text{C}$

Temperature factor $f_{Rsi} = 0.89$

Calculation of structural stability.

Thermal insulation performance at a glance.

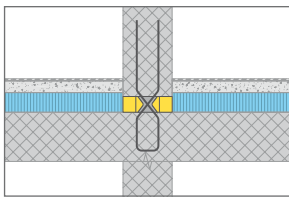

**Wall connection
Inside area
(PSI)**

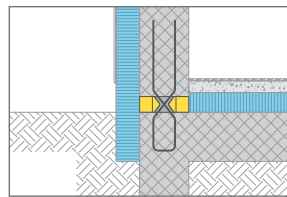

**Wall connection
Base area
(PSI)**

Base situation with 1 element per metre

U value Floor slab [W/(m ² ·K)]	Thermal transmission coefficient ψ [W/(m·K)]
0.10	0.14
0.15	0.13
0.20	0.10
0.25	0.08

Supplement for underfloor heating +0.05 W/(m·K)

Base situation with 1 element per metre

U value Floor slab W/(m ² ·K)]	Thermal transmission coefficient ψ [W/(m·K)]			
	U value of façade [W/(m ² ·K)]			
	0.10	0.15	0.20	0.25
0.10	0.09	0.07	0.05	0.03
0.15	0.07	0.05	0.03	0.01
0.20	0.05	0.03	0.01	-0.01
0.25	0.02	0.00	-0.01	-0.03

Supplement for underfloor heating +0.04 W/(m·K)

Base situation with 2 elements per metre

U value Floor slab [W/(m ² ·K)]	Thermal transmission coefficient ψ [W/(m·K)]
0.10	0.22
0.15	0.20
0.20	0.17
0.25	0.15

Supplement for underfloor heating +0.09 W/(m·K)

Base situation with 2 elements per metre

U value Floor slab W/(m ² ·K)]	Thermal transmission coefficient ψ [W/(m·K)]			
	U value of façade [W/(m ² ·K)]			
	0.10	0.15	0.20	0.25
0.10	0.15	0.14	0.13	0.11
0.15	0.13	0.12	0.10	0.09
0.20	0.11	0.09	0.08	0.07
0.25	0.09	0.07	0.06	0.04

Supplement for underfloor heating +0.07 W/(m·K)

Base situation with 3 elements per metre

U value Floor slab [W/(m ² ·K)]	Thermal transmission coefficient ψ [W/(m·K)]
0.10	0.29
0.15	0.27
0.20	0.24
0.25	0.22

Supplement for underfloor heating +0.13 W/(m·K)

Base situation with 3 elements per metre

U value Floor slab W/(m ² ·K)]	Thermal transmission coefficient ψ [W/(m·K)]			
	U value of façade [W/(m ² ·K)]			
	0.10	0.15	0.20	0.25
0.10	0.22	0.20	0.19	0.13
0.15	0.19	0.18	0.17	0.10
0.20	0.17	0.16	0.14	0.08
0.25	0.15	0.13	0.12	0.06

Supplement for underfloor heating +0.10 W/(m·K)

Equivalent thermal conductivity

Equivalent thermal conductivity λ_{eq} [W/(m·K)]						
Wall thickness	Spacing of individual elements [cm]					
	200	150	100	70	50	30
300	0.06	0.11	0.16	0.20	0.21	0.24
250	0.07	0.12	0.18	0.22	0.24	0.27
200	0.08	0.13	0.20	0.24	0.27	0.30
180	0.08	0.13	0.21	0.25	0.28	0.32

Schöck Alphadock® in comparison: Minimal thermal bridging

This graphic representation enables simple comparison of the solutions for minimising thermal bridges when connecting reinforced concrete walls. You will quickly notice that Schöck Alphadock® is the only solution capable

of resolving all connection issues and, at the same time, demonstrating the best insulation performance in each situation. The graphic shows the installation situation of an interior wall on an underground garage ceiling.

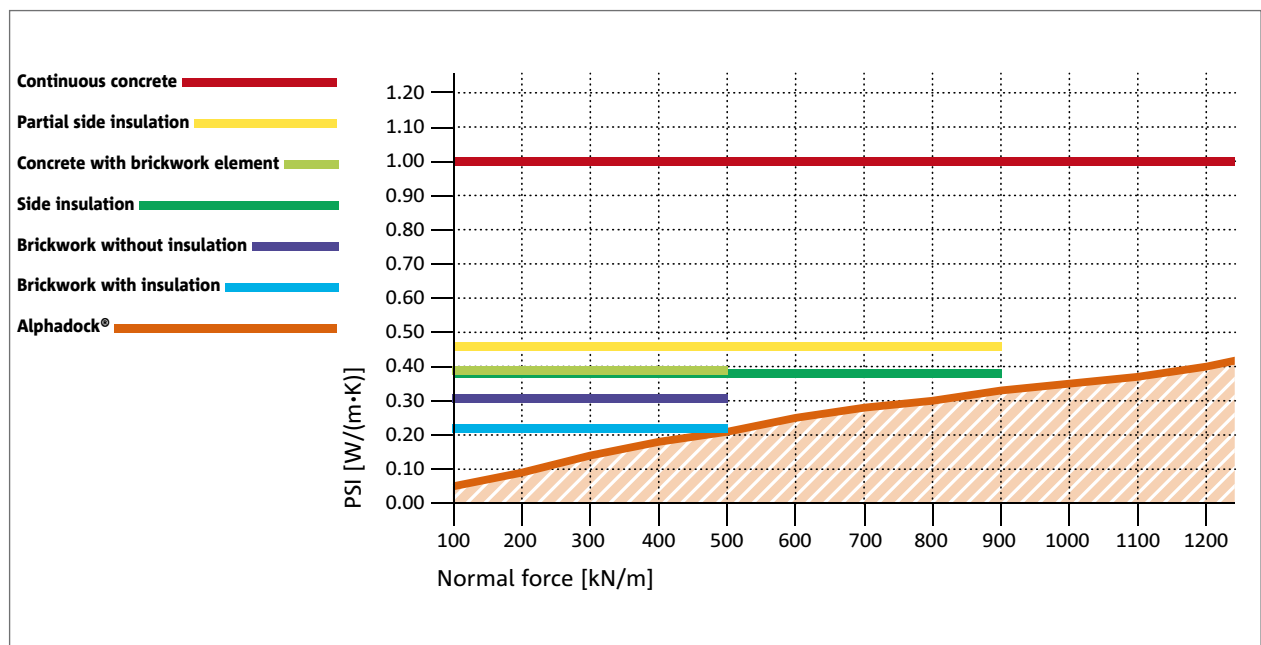

Makes planning easier and better

When planning with Schöck Alphadock®, experience has shown the advisability of raising the proportion of reinforced concrete walls in both the cellar and ground floor in the interests of both structural stability and

building physics. In addition to the cheaper structural stability design, it vastly improves PSI performance, even when compared to insulated brickwork designs.

Components and properties.

Components in detail.

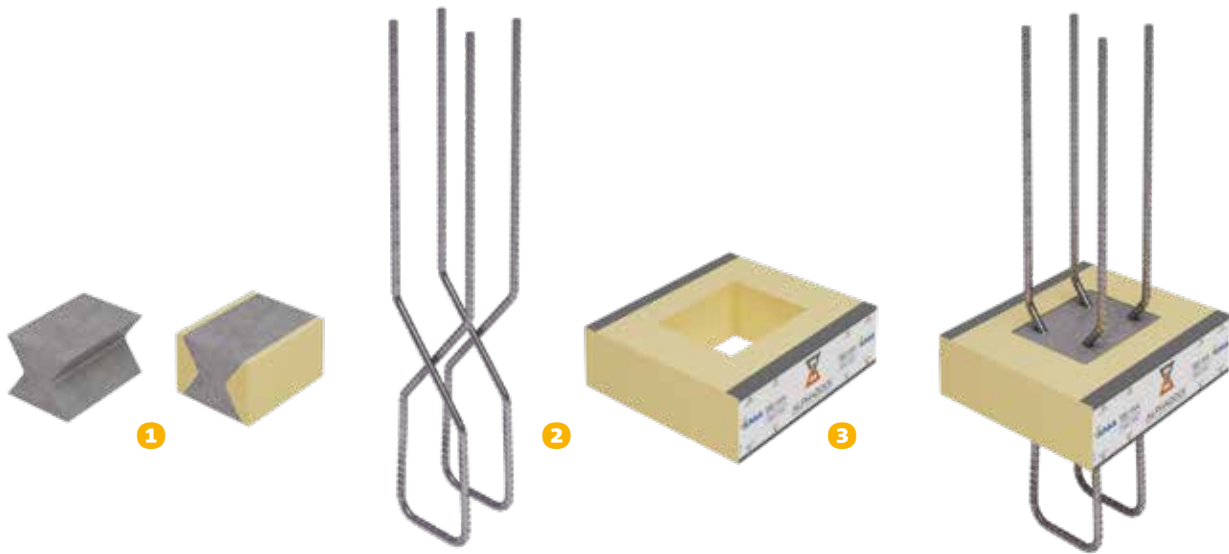

1 UHPFRC element

The pressure buffer on a Schöck Alphadock® is made from ultra high performance fibre reinforced concrete. This material achieves compressive strength levels in excess of 175 N/mm^2 but with extremely good flexural strength as well. The addition of steel fibres also produces excellent fracture behaviour. The design level of Alphadock® was tested to $N_{Rd} = 760 \text{ kN}$ (5% fractile). As such, the system's failure criterion is always the adjacent in-situ concrete. Arithmetical verification must be based on a compression surface of $100 \times 150 \text{ mm}$.

2 Steel stirrups

The steel stirrups are made from normative BSt 500 B, 10 mm in diameter. In standard applications, adequate concrete cover protects the steel against corrosion.

3 Insulation

The insulation surrounding the UHPFRC element is swisspor XPS 500. The technical characteristic values are as follows:

Thermal conductivity λ :	0.036 W/(m·K)
Water vapour diffusion resistance:	250 – 80
Long-term water absorption:	< 0.2 Vol – %
Compressive stress 10% strain:	> 500 kPa
Compressive stress 2% strain:	> 180 kPa

Please ask our team of advisers for more information.

A pressure buffer made of UHPFRC encased in XPS insulation, together with additional steel stirrups – these three base materials together form the top connection for reinforced concrete walls. What sounds easy is actually the result of long years of research and development. The physical properties of Schöck Alphadock® are clearly defined. A UHPFRC block assures the pressure transfer (reinforcements were not included in the calculation of the compression forces). The pressure bearing element was developed specifically for this purpose together with Holcim. To optimise the transmission loss, the pressure buffer tapers from compression surface towards the centre of the element.

Reinforcements

To assure load bearing capacity, the reinforcements must be arranged as shown in Figs. 2 and 3. Stirrups must be used to anchor the longitudinal reinforcements at the ends of the walls.

- 1 Overview floor slab/ceiling system
- 2 Reinforcement Schöck Alphadock® ceiling
- 3 Reinforcement Schöck Alphadock® floor slab

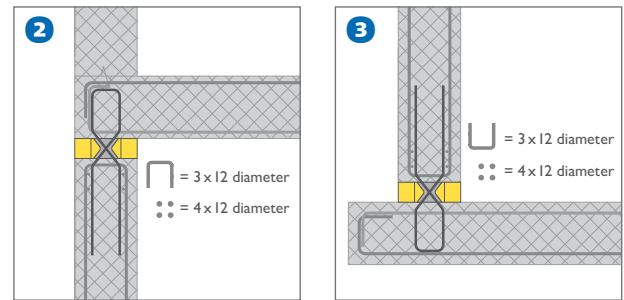

Load bearing capacity

You can build on this.

Resistance performance in states of spatial tension

Spacing of individual elements [mm]	Wall thickness											
	300 mm			250 mm			200 mm			180 mm		
	n_{Rd}^* [kN/m]	V_{Rd} [kN/m]	h_{Rd} [kN/m]	n_{Rd}^* [kN/m]	V_{Rd} [kN/m]	h_{Rd} [kN/m]	n_{Rd}^{**} [kN/m]	V_{Rd} [kN/m]	h_{Rd} [kN/m]	n_{Rd}^{***} [kN/m]	V_{Rd} [kN/m]	h_{Rd} [kN/m]
1000	606	88	59	525	88	59	429	66	59	429	44	59
500	1212	176	118	1050	176	118	857	132	118	857	88	118
300	1650	293	197	1429	293	197	1167	220	197	1167	147	197

* The engineer must assure the three-dimensional state of compressive stress. This can normally be reliably assured by inserting the expansion reinforcement (see drawing).

** Because the wall is thin, particular attention must be paid to the three-dimensional state of compressive stress. If the iron cover is less than 40 mm, this state can normally be achieved by inserting the expansion reinforcement.

*** The three-dimensional state of compressive stress can only be achieved with an iron cover of 20 mm and with insertion of the expansion reinforcement (see drawing). Thicker iron covers or omission of the expansion reinforcement result in a one-dimensional state of stress.

Pressure loads in the absence of states of spatial tension

If a state of spatial compressive tension cannot be achieved due to cutouts, special geometries or the absence of expansion reinforcement, the 1-axial transfer values listed below must be applied. The values are determined as the product of $N_{Rd} = A_c \cdot f_{cd}$. For purposes of calculation, the compression surface A_c to the in-situ concrete must be $150 \cdot 100$ mm.

N_{Rd}	Concrete class		
	C20/25	C25/30	C30/37
	202.5 kN	247.5 kN	300 kN

View

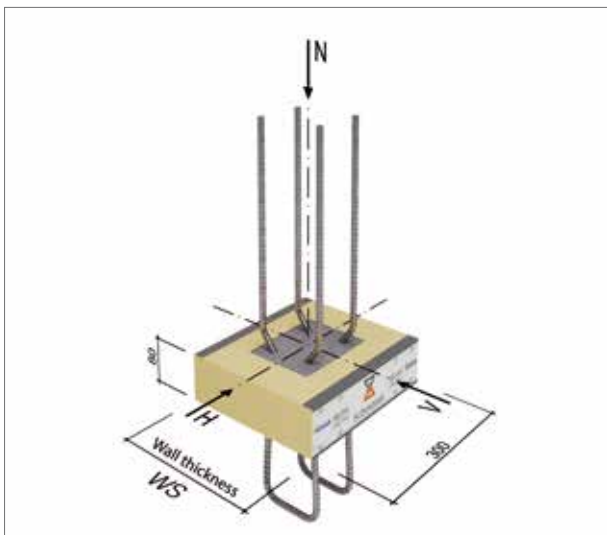

Section and size of reinforcement

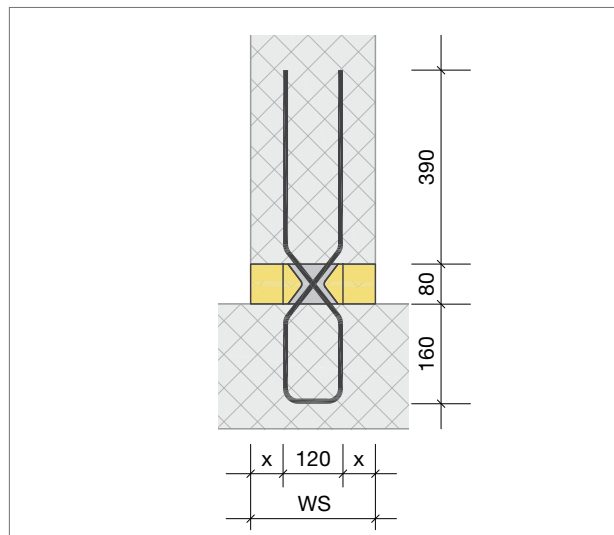

System computation model

Wall – floor slab/ceiling

Calculation is based on the assumption of a 3-D state of tension as per the computation models in SIA 262 Sections 4.2.1.10 and 4.2.1.11. This state was verified in system tests.

Basic verification data	
Spacing of the elements in the longitudinal wall axis	a_1
Wall thickness	h
Concrete cover	nom c
Compressive strength of concrete as per SIA 262 Table 8	f_{cd}
Buffer compression surface	A_{c0}

Computation model	
$N_{Rd} = f_{cd} \cdot A_{c0}$	
$A_{c0} = 100 \cdot 150 = 15.000 \text{ mm}^2$	
$f_{cd} = k_c \cdot f_{ctd}$	
$b = h - 2 \cdot (\text{nom } c + \varnothing)$	
$a_1 = \text{spacing of individual elements} > 3 \cdot 150 = 450 \text{ mm}$	
$k_c = \sqrt{\frac{A_{c1}}{A_{c0}}} = \sqrt{\frac{a_1 \cdot b_1}{100 \cdot 150}}$	

Maximum load bearing capacity per Schöck Alphadock®

The transverse and horizontal load bearing abilities are determined on the basis of the load bearing capacity of the steel, as defined in SIA 262, and based on anchor theories (as per EOTA TR029). A proportionate load from the UHPFRC (friction) was not included in the calculation.

$$N_{Rd} = 760 \text{ kN}$$

$$V_{Rd} = 88 \text{ kN}$$

$$H_{Rd} = 59 \text{ kN}$$

Interaction

Linear interaction must be performed to determine the combined load in both horizontal directions. This produces the following interaction:

$$1 \geq \frac{V_{Ed}}{V_{Rd}} + \frac{H_{Ed}}{H_{Rd}}$$

Temperature-related deformation

Temperature-related deformation of Alphadock® elements must be limited to +/- 1.0 mm. Normally, this can be easily verified by reducing the cross section surfaces (door openings, window openings, parapets and other cutouts/inserts) and the associated crack formation. If verification proves difficult on longer uninterrupted shear walls, however, expansion joints must be incorporated accordingly.

Spring strength per Alphadock®

The spring stiffnesses of the elements were verified in system tests. Within these parameters, the elements largely remain within the elastic range. The spring stiffnesses per element are as follows:

Normal force spring k_D	= 700 kN/mm
Shear force spring k_V	= 87.5 kN/mm
Longitudinal force spring k_H	= 125 kN/mm

Spring strength			
Spacing of individual elements [mm]	Compression spring	Shear force spring	Longitudinal shear spring
	k_D [kN/mm]	k_V [kN/mm]	k_H [kN/mm]
1000	700	87.5	125
500	1400	175	250
300	2333	292	417

Guaranteed maximum safety.

Fire protection, water tightness and earthquake resistance.

Fire protection

When incorporating Schöck Alphadock® into the base of a wall, the design must ensure that the upper edge of the component is beneath the lower edge of the screed (fire behaviour A) of the floor slab/ceiling. When incorporating it at the top of a wall, the adjacent insulation

beneath the ceiling must be at least 140 mm thick and must be non-combustible (A1 as per EN 13501-1). If the adjacent insulation (A1) beneath the ceiling is not at least 140 mm thick or is combustible, the joint must be clad with fireproof material.

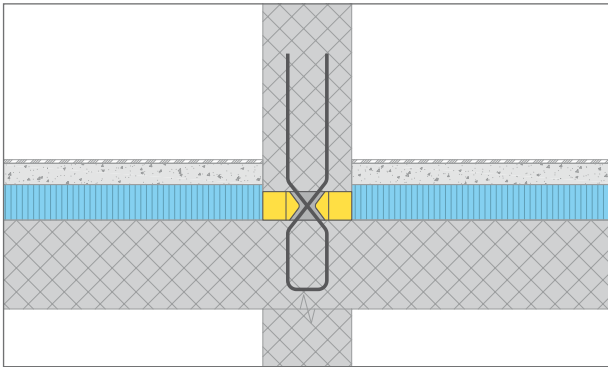

Base of a wall

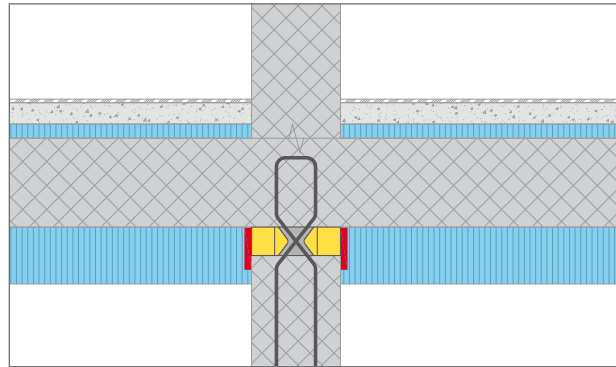

Top of a wall

Waterproof against moisture from the ground (not pressing water)

- Sikadur-Combiflex SG-10 P or similar can be used as a sealant.
- If the thermal insulation is already pressure resistant, no further mechanical protection is generally needed.
- Other designs, e.g. yellow lining (SikaProof), can also be implemented.
- Please contact our team of advisers for help with this solution.
- The sealant must be suitable for joints that expand by +/- 2.0 mm and joint widths of 80 mm.

Waterproof against pressing water

A standardised solution is not possible, given the differing conditions and options for designing the base of a wall to resist pressing water. If you have any questions, please contact our team of advisers.

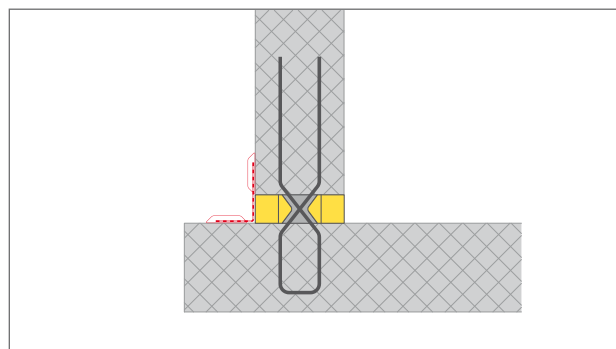
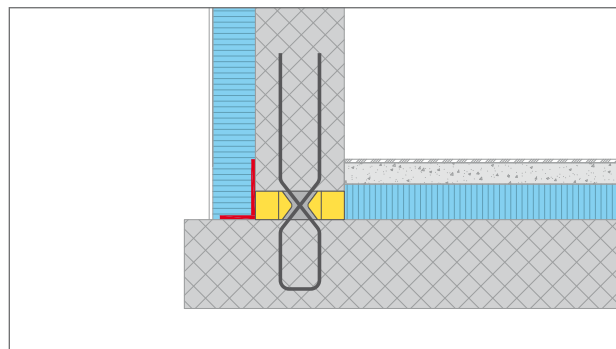

Earthquake resistance

- ▶ When considering earthquake resistance, the design values in the longitudinal direction of a wall must be taken into account as per the «Design values» table (elastic range). The material safety factors γ_M must not be reduced.
- ▶ If these factors are not sufficient, normal concrete construction solutions must be implemented. Our technical experts are happy to advise you.
- ▶ Earthquake stress produces increased horizontal loads that result in the shear reinforced concrete walls being exposed to greater bending stress. If the stabilising shear reinforced concrete walls are positioned properly throughout the building, the moment loads will be overridden by the normal forces. Thermally insulated connection of these walls can only be achieved with the use of Schöck Alphadock®. If this structural stability is no longer assured, tie members must be incorporated into the design engineering (see illustrated example).

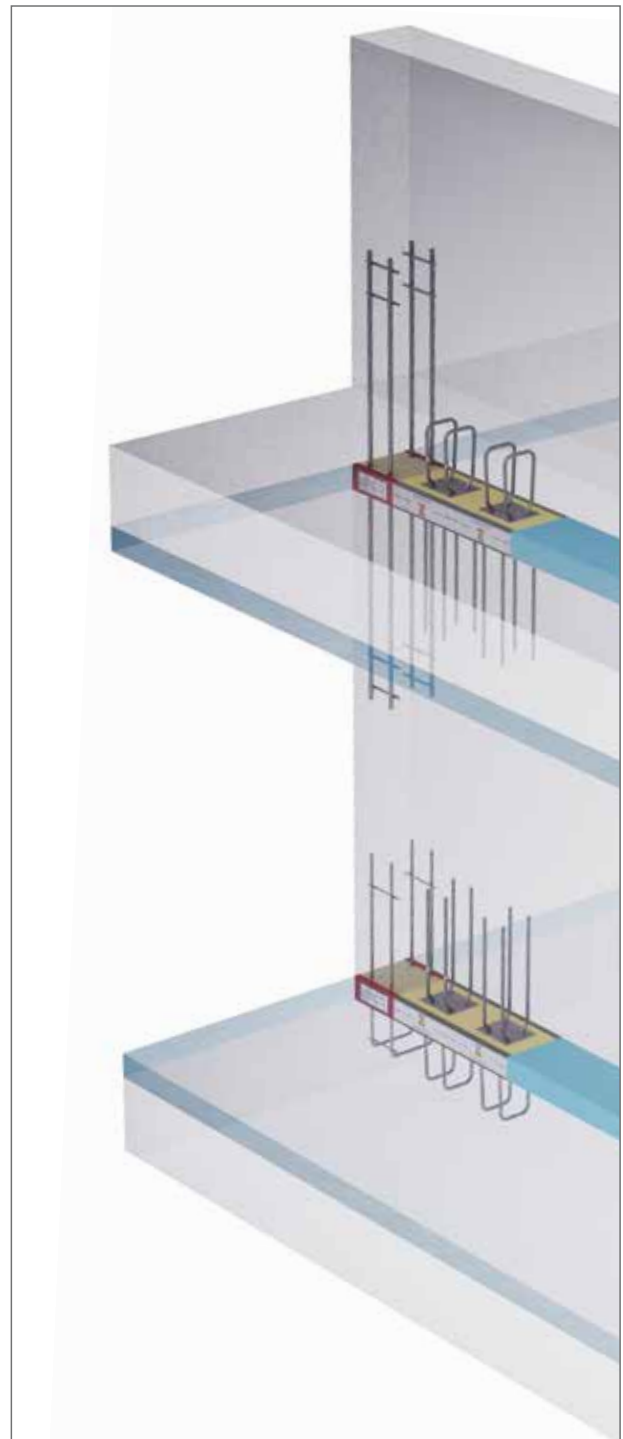

Installation information.

How to reliably install Schöck Alphadock®.

Schöck Alphadock® is an articulated connection

Free standing walls without lateral support must be propped up after removal of the formwork until spatial stability is assured. Verification of the thrust and shear force of the in-situ concrete used for the adjacent components

must be provided by the engineer in charge. Permissible deformation as a result of stress force (e.g. temperature) must be limited to maximum 1 mm.

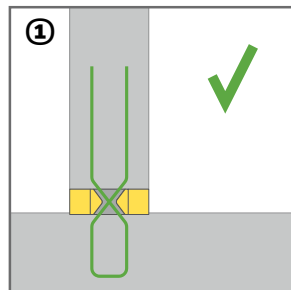
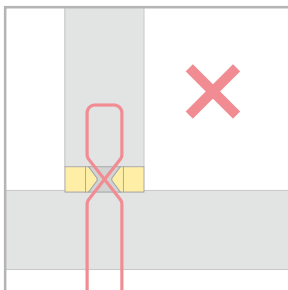

① Stirrup position

Closed side facing the ceiling.

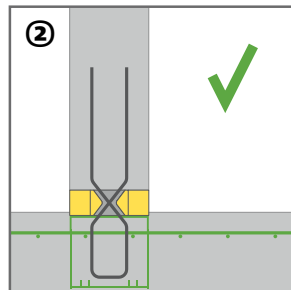
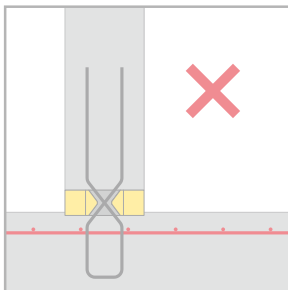

② Mounting rail

Fasten the mounting aid to the formwork beforehand.

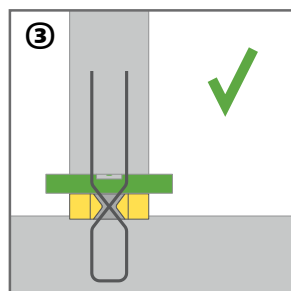
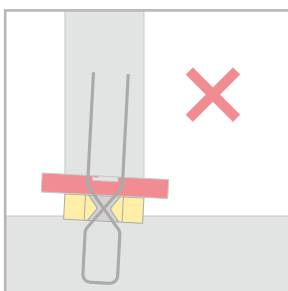

③ Horizontal

Make sure the element is installed horizontally.

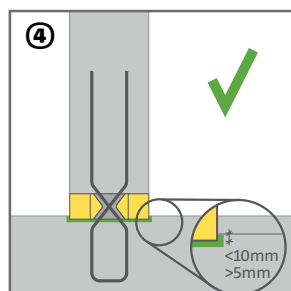
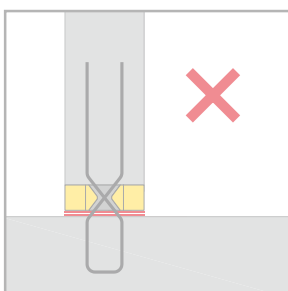

④ Element installation depth

Element must be embedded 5 – 10 mm in the concrete.

The use of Alphadock® is very similar to that of a conventional parapet connection. Alphadock® must be fastened at distances calculated by the engineer to the reinforcement of the floor or ceiling slab and cast in concrete. The gaps in-between are then thermally insulated using conventional XPS. The usual procedure can then be applied to installing the reinforced concrete wall – formwork, reinforcement, concrete cover.

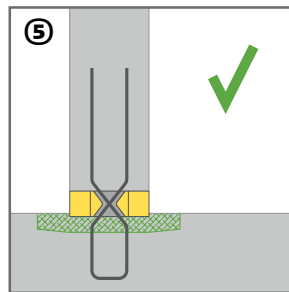
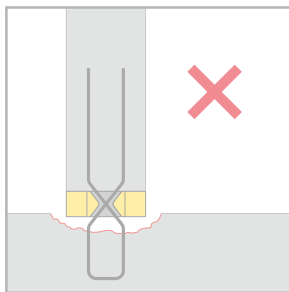

⑤ Bedding

Cavities beneath the element must be avoided.

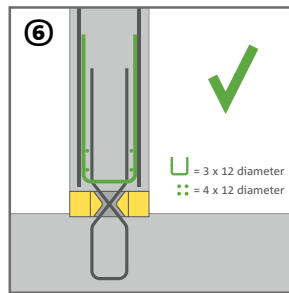
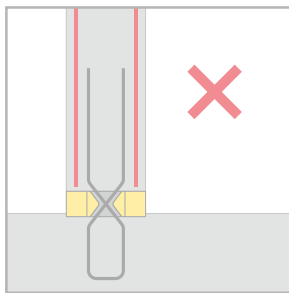

⑥ Reinforcements

Structural reinforcement must be positioned correctly (3 × 12 diameter stirrups, 4 × 12 diameter long irons).

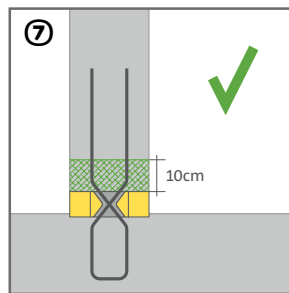
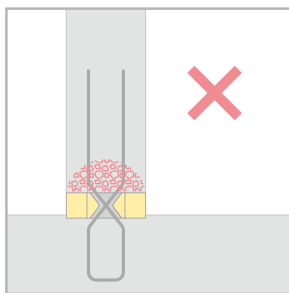

⑦ Gravel pockets

Gravel pockets above the element are not permissible (pour preparatory concrete, if necessary).

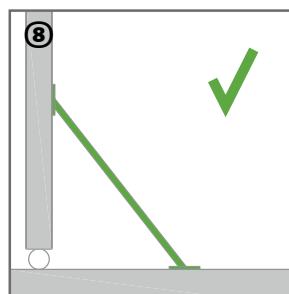
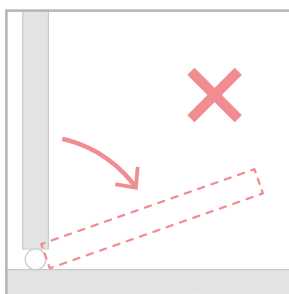

⑧ Wall tilt protection

Secure the wall against tilting after removing the formwork (articulated connection).

Technical details are subject to change
Issued: July 2019

Schöck Bauteile GmbH
Vimbucher Strasse 2
76534 Baden-Baden, Germany
Telephone: +49 7223 967-144
Fax: +49 7223 967-7634
export@schoeck.com
www.schoeck.com

