

Certificate

Certified Passive House Component

for cool, temperate climate, valid until 31.12.2024

Category: **Roof parapet connection**
 Manufacturer: **Schöck Bauteile GmbH**
76534 Baden-Baden GERMANY
 Product name: **Schöck Isokorb® XT Typ A**

The following criteria were used in awarding this certificate:

Efficiency Criterion

The construction fulfils the requirement

$$\Psi \leq 0.010 \text{ W/(mK)}$$

Comfort Criterion

The inner surface must be warm enough to prevent mould as well as uncomfortable down-draught and radiation losses.

$$\theta_{i,\min} \geq 17^\circ\text{C}$$

Thermal data

Typ	thermal bridge coefficient Ψ [W/(mK)]	minimum inner surface temperature $\theta_{i,\min}$ [°C]
XT Typ A-MM1-VV1-B150	-0.003	18.73
XT Typ A-MM1-VV1-B200	-0.001	18.72
XT Typ A-MM1-VV1-B250	0.004	18.69
XT Typ A-MM2-VV1-B150	0.002	18.64
XT Typ A-MM2-VV1-B200	0.004	18.64
XT Typ A-MM2-VV1-B250	0.009	18.62

The certificate includes types with minor statical performance. Thermal bridge coefficients can be approximated by linear interpolation. The stated Ψ -values are valid for an element distance (axis-center distance) of 1,0 m. If larger distances are used, Ψ decreases.

www.passivehouse.com

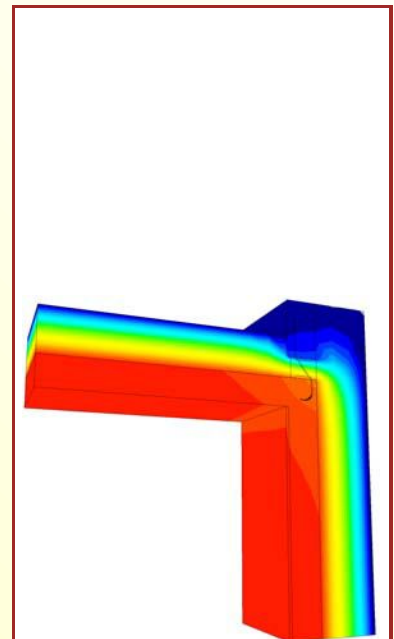

Isothermal map of
XT Typ A-MM1-
VV1-B150

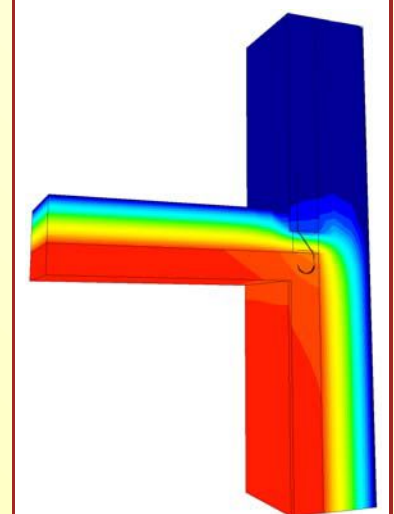

Isothermal map of
XT Typ A-MM2-
VV1-B150

cool, temperate climate



**CERTIFIED
COMPONENT**

Passive House Institute